

OnLevel glasværn	s.	7
Balustre	s.	27
Håndlister	s.	37
Klembeslag	s.	49
Punktholdere	s.	55
Glastag	s.	57

10. GLASVÆRN GLASTAG

Hansen Lellinge A/S er leverandør for alt inden for glasmontage. Vi kan hjælpe med rådgive og finde de rette beslag til din glasdørsløsning, alt efter dine ønsker og behov.

I dette katalog præsenterer vi indespændt glasværn, balustre, håndlister, klembeslag, punktholdere og glastage.



Indholdsfortegnelse

Balustre

Firkantet sidemonteret	33
Firkantet sidemonteret til trapper	35
Firkantet topmonteret.....	29
Firkantet topmonteret til trapper	31
Runde sidemonteret.....	30
Runde sidemonteret til trapper.....	34
Runde topmonteret	28
Runde topmonteret til trapper	32

Glastag

Baldakinprofiler.....	58
Baldakin med stænger firkantet	61
Baldakin med stænger runde	60
Glastagsprofiler	62

Håndlister

Rund aluminium	40
Rund rustfrit stål	44
Rund rustfrit stål	46
U-profil aluminium.....	38
U-profil rustfrit stål	42

Indespændt værn

Flexfit	24
Sidemonteret 6021	16
Sidemonteret i flange 3011	10
Tilbehør indespændt værn	24
Topcover profiler.....	22
Topmonteret 6020.....	14
Topmonteret i flange 3010	8
Vindafskærmning 0,5 kN 6500.....	20
Vindafskærmning 1,5 kN 4010.....	12

Klembeslag

D-formet.....	50
Firkantet	51
Runde.....	52
Specielle	53

Punktholdere

Punktholdere	55
--------------------	----



OnLevel glasværn



	OnLevel	OnLevel	OnLevel	OnLevel	OnLevel	OnLevel
Type	3010	3011	4010	6020	6021	6500
For glas/plade	12 - 21,52 mm	12 - 21,52 mm	12 - 21,52 mm	12 - 21,52 mm	12 - 21,52 mm	12 - 21,52 mm
Type	topmonteret	sidemonteret	topmonteret	topmonteret	sidemonteret	topmonteret
Justerbar	Flex-fit	Flex-fit	Flex-fit	Flex-fit	Flex-fit	Flex-fit
Max. belastning	1,5 kN	1,5 kN	1,5 kN	1,5 kN	1,5 kN	1,5 kN
Overflade ¹	R,N,RAL,SS,MS	R,N,RAL,SS,MS	R,N,RAL,SS,MS	R,N,RAL,SS,MS	R,N,RAL,SS,MS	R,N,RAL,SS,MS
Produktdata	s. 8	s. 10	s. 12	s. 14	s. 16	s.20

¹⁾ R = Rå, N= Naturelokeret, RAL= RAL-farve, SS = sort struktur, MS = Matsort

Balustre



	JNC	JNC	JNC	JNC	JNC	JNC
Type	topmonteret runde rør	topmonteret firkantet rør	topmonteret runde rør f. trapper	topmonteret firkantet rør f. trapper	sidemonteret runde rør	sidemonteret firkantet rør
For glas/plade	8 - 12,76 mm	8 - 12,76 mm	8 - 12,76 mm	8 - 12,76 mm	8 - 12,76 mm	8 - 12,76 mm
Overflade	rustfrit stål	rustfrit stål	rustfrit stål	rustfrit Stål	rustfrit stål	rustfrit stål
Produktdata	s. 28	s. 29	s. 30	s. 31	s. 32	s. 33

Håndlister



	OnLevel	JNC	OnLevel	OnLevel	OnLevel
	U-profil	Rundprofil	U-profil	Rundprofil	Rundrør
For glas	8 - 21,54 mm	12,76 - 21,54 mm	8 - 31,50 mm	8 - 21,54 mm	-
Overflader ¹	R,N,RAL,SS,MS	R,N,RAL,SS,MS	AISI	AISI	AISI
Materiale	aluminium	aluminium	rustfrit stål	rustfrit stål	rustfrit stål
Produktdata	s. 38	s. 40	s. 42	s. 44	s. 46

¹⁾ R = Rå, N= Naturelokeret, RAL= RAL-farve, SS = sort struktur, MS = Matsort

Klembeslag

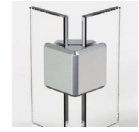

	Pauli	Pauli	Pauli	Pauli	
eldrevne horisontale	D-formet	Firkantet	Runde	Specialbeslag	Hjørnebeslag
Glastykkelse	8 - 12,76 mm	8 - 12,76 mm	8 - 12,76 mm	12 - 17,52 mm	8 - 12,76 mm
Materiale	zink/rustfrit stål	zink/rustfrit stål	zink	zink	zink
Produktdata	s. 50	s. 51	s. 52	s. 53	s. 53

Punktholdere



	JNC	JNC
	sidemonteret runde rør f. trapper	sidemonteret firkantet rør f. trapper
	8 - 12,76 mm	8 - 12,76 mm
	rustfrit stål	rustfrit stål
	s. 34	s. 35

	Pauli
	Runde
For glas	6 - 21,52 mm
Materiale	AISIS 304 og 316
Overflade	rustfrit stål
Produktdata	s. 55

Glastag

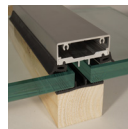

	Pauli	Pauli	JNC
	Baldakin profil	Baldakin stænger	Glastagsprofil
For glas	17,52 mm	12,76 - 17,56 mm	6 / 8 mm
Max. størrelse	2400 x 1100 mm	1,4 x 1 m pr. 2 sæt	-
Materiale	aluminium	rustfrit stål	aluminium
Produktdata	s. 58	s. 60	s. 62



Indespændt glasværn ONLEVEL

Produktoversigt 4

Værnprofiler:

Type 3010	8
Type 3011	10
Type 4010	12
Type 6020	14
Type 6021	16
Type 6500I	20
Topcoverprofiler	22
Flex-Fit	24
Tilbehør	25

OnLevel

OnLevel er en specialiseret producent af indespændt værn, som fås i mange forskellige typer og som kan dække ethvert behov. Deres kendte Flex-Fit system udmærker sig ved, at et værktøj kan bruges til alle typer af deres profiler, og kan justere glasset millimeter præcist fra den indvendige side. OnLevel har altid bevidst prøvet på at reducere montagetiden ved nybyggeri.

Onlevel type 3010 1,0 kN topmonteret i flange

- o Slankt, attraktivt design i aluminium med minimal vedligeholdelse.
- o Onlevel Flex-fit glasmontagesystem (se side 24)
- o Integreerede drænhuller
- o Fås også i højere sikkerhed, 3,0 kN
- o Glastykkelse fra 12 mm - 21,52 mm
- o Ekskl. glas

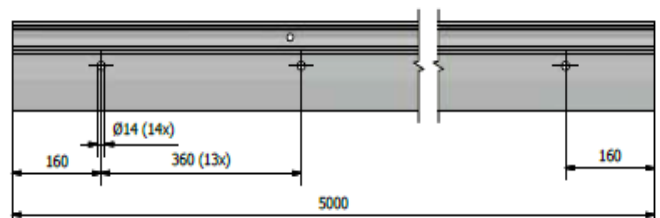
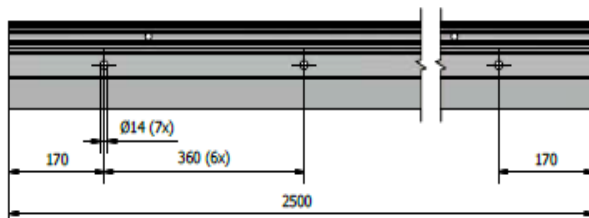
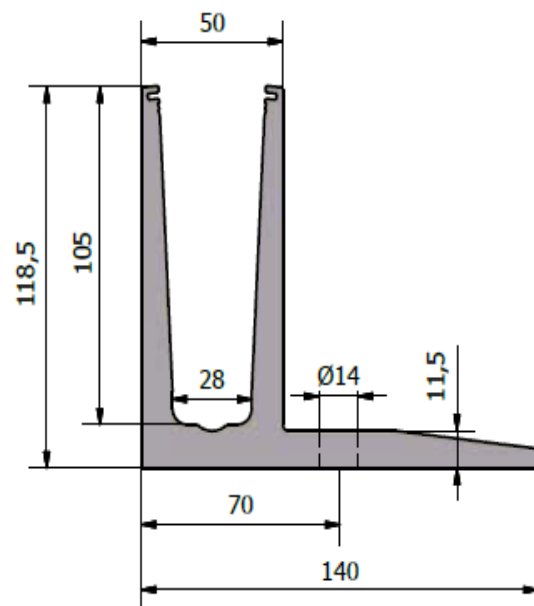
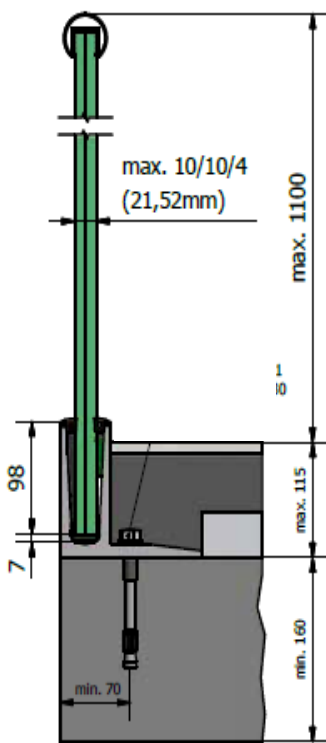

10

3010 Glasværnsprofil topmonteret i flange

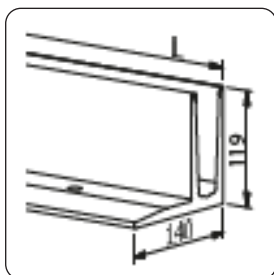

Varenummer	overflade	længde	typenummer
135.3T5.100	rå	5.000 mm	-
135.3T5.101	naturelokseret	5.000 mm	
135.3T5.103	pulverlakeret	5.000 mm	
135.3T5.106	sort struktur	5.000 mm	
135.3T5.108	mat	5.000 mm	

3010 Indvendigt hjørne

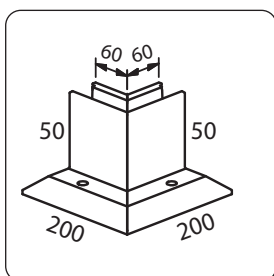
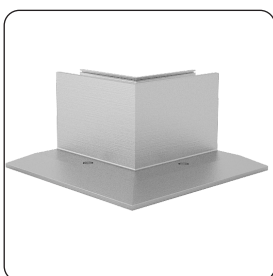

Varenummer	overflade	typenummer
135.3TI.100	rå	-
135.3TI.101	naturelokseret	
135.3TI.103	pulverlakeret	
135.3TI.106	sort struktur	
135.3TI.108	matsort	

3010 Udvendt hjørne

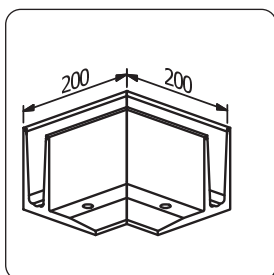

Varenummer	overflade	typenummer
135.3TU.100	rå	-
135.3TU.101	naturelokseret	
135.3TU.103	pulverlakeret	
135.3TU.106	sort struktur	
135.3TU.108	matsort	

3010 Endebund venstre/højre

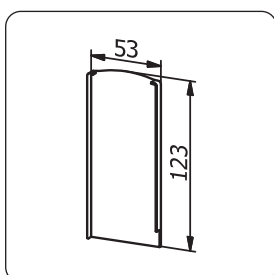
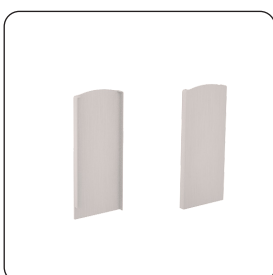

Varenummer ¹⁾	overflade	typenummer
135.3T*.100	rå	-
135.3T*.101	naturelokseret	
135.3T*.103	pulverlakeret	
135.3T*.106	sort struktur	
135.3T*.108	mat	

¹⁾ *byttes ud med henholdsvis L for venstre og R for højre

3010 Endebund for trappe, venstre/højre

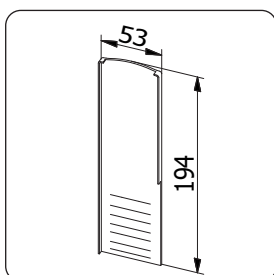
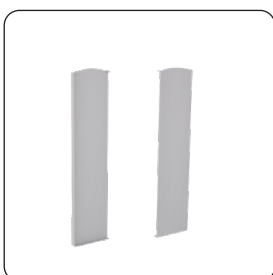

Varenummer ¹⁾	overflade	typenummer
135.3T*.1T0	rå	-
135.3T*.1T1	naturelokseret	
135.3T*.1T3	pulverlakeret	
135.3T*.1T6	sort struktur	
135.3T*.1T8	mat	

¹⁾ *byttes ud med henholdsvis L for venstre og R for højre

Onlevel type 3011 1,0 kN sidemonteret i flange

- o Slankt, attraktivt design i aluminium med minimal vedligeholdelse.
- o Onlevel Flex-fit glasmontagesystem (se side 24)
- o Integreerede drænhuller og kanal for samlepind
- o Topcover tilpasningsprofil
- o Glastykkelse fra 12 mm - 21,52 mm
- o Ekskl. glas

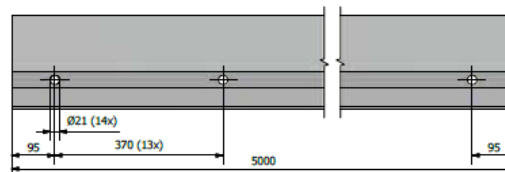
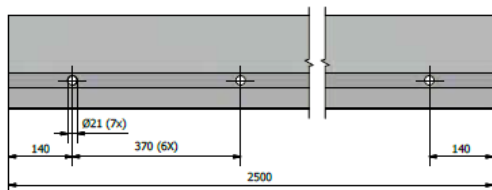
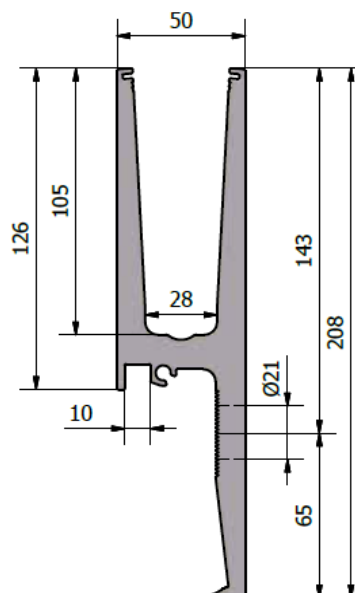
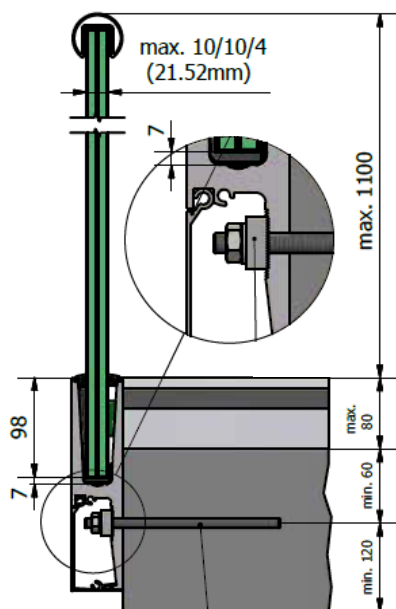

3011 glasværnsprofil sidehængt

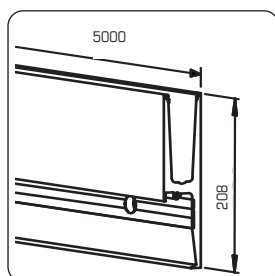

Varenummer	overflade	længde	typenummer
135.3S5.100	rå	5000 mm	-
135.3S5.101	naturelokseret	5000 mm	
135.3S5.103	pulverlakeret	5000 mm	
135.3S5.106	sort struktur	5000 mm	
135.3S5.108	matsort	5000 mm	

3011 Indvendigt hjørne, sidemonteret i flange

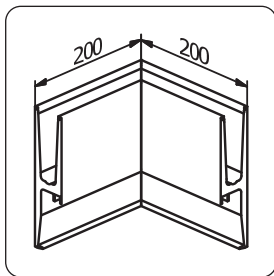
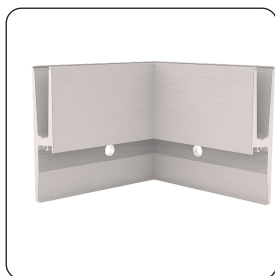

Varenummer	overflade	typenummer
135.3SI.100	rå	-
135.3SI.101	naturelokseret	
135.3SI.103	pulverlakeret	
135.3SI.106	sort struktur	
135.3SI.108	matsort	

3011 Udvendigt hjørne sidemonteret i flange

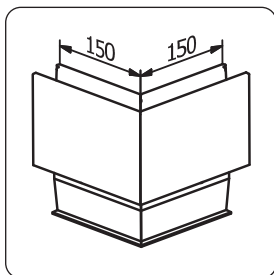

Varenummer	overflade	typenummer
135.3SU.100	rå	-
135.3SU.101	naturelokseret	
135.3SU.103	pulverlakeret	
135.3SU.106	sort struktur	
135.3SU.108	matsort	

3011 Dækprofil

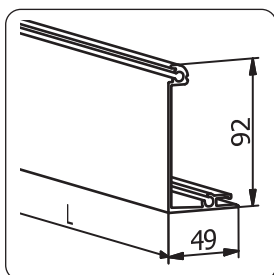
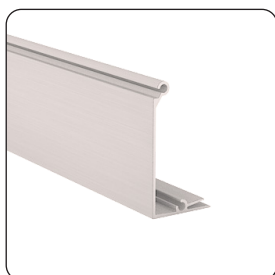

Varenummer	overflade	længder	typenummer
135.3C5.100	rå	5.000 mm	-
135.3C5.101	naturelokseret	5.000 mm	
135.3C5.103	pulverlakeret	5.000 mm	
135.3C5.106	sort struktur	5.000 mm	
135.3C5.108	matsort	5.000 mm	

3011 Endebund venstre/højre

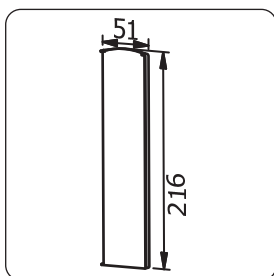
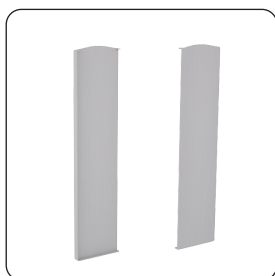

Varenummer ¹⁾	overflade	typenummer
135.3S*.100	rå	-
135.3S*.101	naturelokseret	
135.3S*.103	pulverlakeret	
135.3S*.106	sort struktur	
135.3S*.108	matsort	

¹⁾ *byttes ud med henholdsvis L for venstre og R for højre

3011 Endebunde for trappe venstre/højre

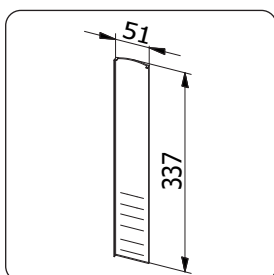

Varenummer ¹⁾	overflade	typenummer
135.3S*.1T0	rå	-
135.3S*.1T1	naturelokseret	
135.3S*.1T3	pulverlakeret	
135.3S*.1T6	sort struktur	
135.3S*.1T8	matsort	

¹⁾ *byttes ud med henholdsvis L for venstre og R for højre

Onlevel type 4010 vindafskærmningsprofil 1,5 kN topmonteret

- o Slankt, attraktivt design i aluminium med minimal vedligeholdelse
- o Onlevel Flex-fit glasmontagesystem (se side 24)
- o Integreerede drænhuller og stifthuller til forlængelse
- o Kun til 21,52 mm lamineret/hærdet glas
- o Ekskl. glas

riba
product
selector

Vindafskærmning

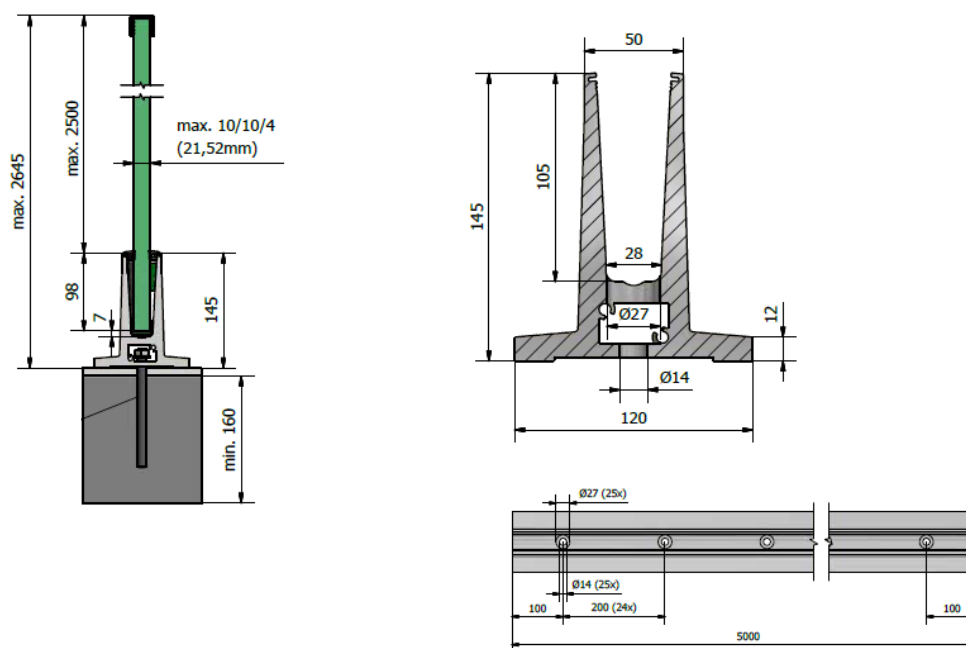

Værn

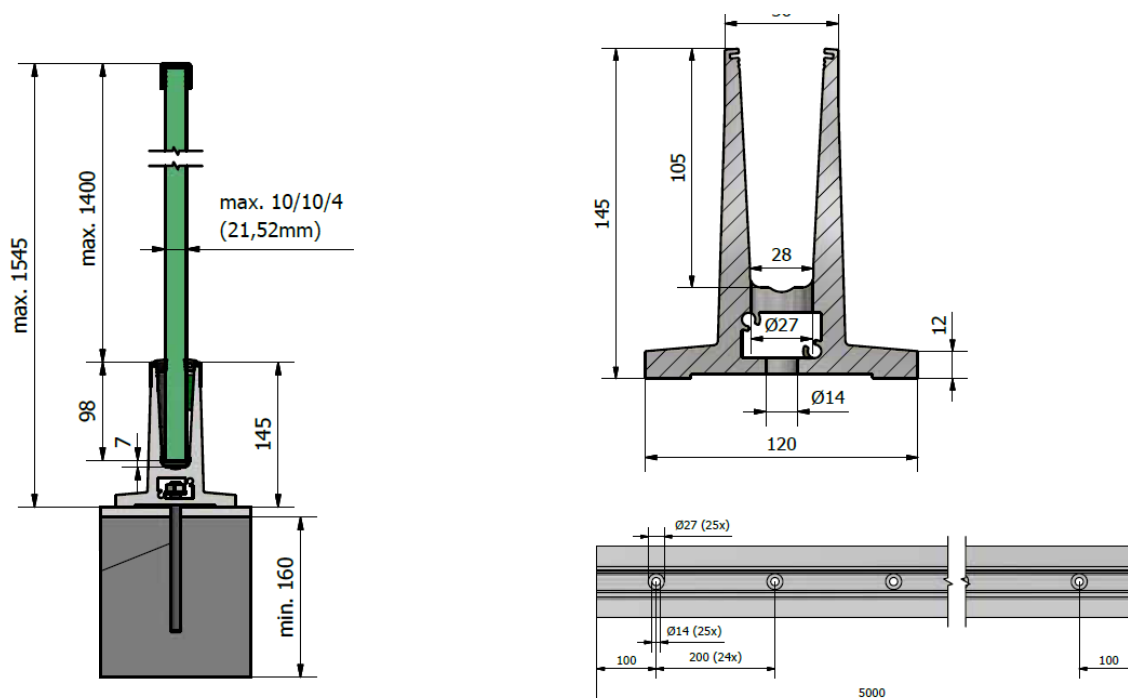

4010 Vind- og værnafskærmningprofil

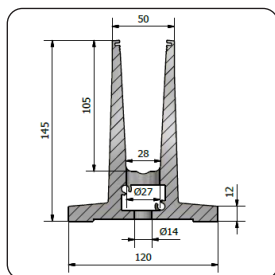

Varenummer	overflade	længde	typenummer
135.4T5.100	rå	5000 mm	-
135.4T5.101	elokseret	5000 mm	-
135.4T5.103	RAL farve	5000 mm	-
135.4T5.106	struktur sort	5000 mm	-
135.4T5.108	matsort	5000 mm	-

4010 Ud- og Indvendigt hjørne

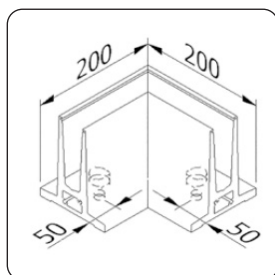
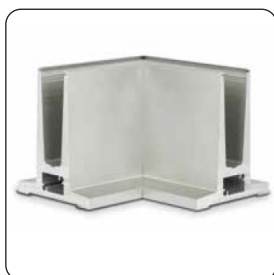

Varenummer	overflade	typenummer
135.4TV.100	rå	-
135.4TV.101	elokseret	-
135.4TV.103	RAL farve	-
135.4TV.106	sort struktur	-
135.4TV.108	matsort	-

4010 Endebund venstre/højre

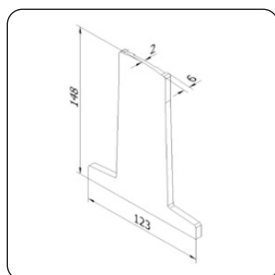

Varenummer	overflade	typenummer
135.4TE.100	rå	-
135.4TE.101	elokseret	-
135.4TE.103	RAL farve	-
135.4TE.106	sort struktur	-
135.4TE.108	matsort	-

4010 Afstandsstykke for dræn

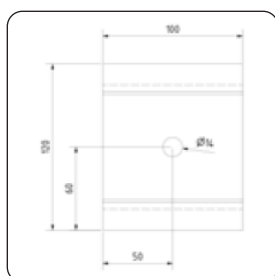

Varenummer	overflade	typenummer
135.4TA.000	rå	-
135.4TA.001	elokseret	-
135.4TA.003	RAL farve	-
135.4TA.106	sort struktur	-
135.4TA.008	matsort	-

4010 Samlepind for samling af to profiler

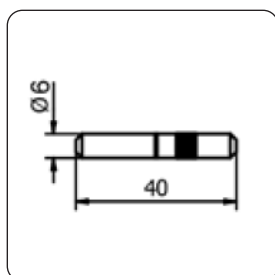

Varenummer	overflade	typenummer
135.PIN.000	rustfrit stål	-

Onlevel type 6020 1,5 kN topmonteret i profil

- o Slankt, attraktivt design i aluminium med minimal vedligeholdelse.
- o Onlevel Flex-fit glasmontagesystem (se side 24)
- o Integreerede drænhuller og kanal for samlepinde
- o Topcover 3,0 kN tilpasningsprofiler
- o Glastykkelse fra 12 mm til 21,52 mm
- o Ekskl. glas

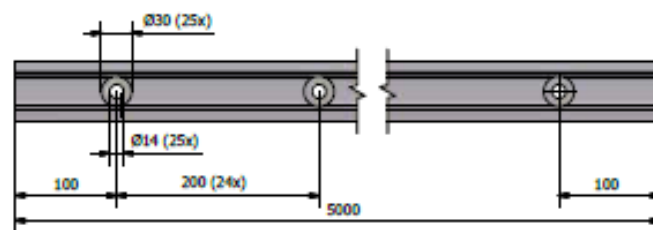
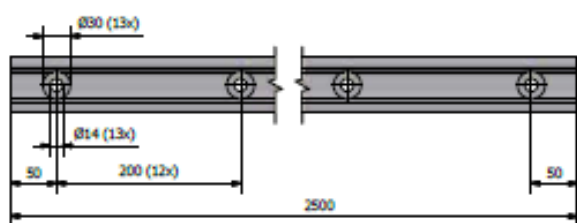
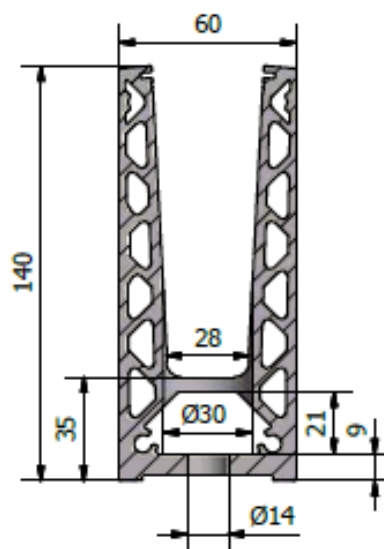
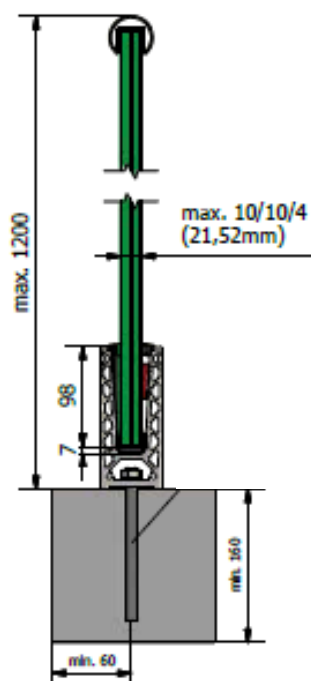

10

6020 Glasværnsprofil topmonteret i profil

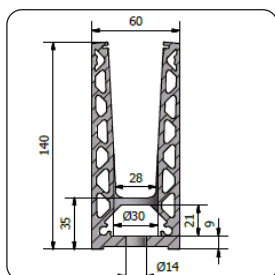

Varenummer	overflade	længde	typenummer
135.6T5.100	rå	5000 mm	-
135.6T5.100	naturelokseret	5000 mm	
135.6T5.103	pulverlakeret	5000 mm	
135.6T5.100	sort struktur	5000 mm	
135.6T5.100	matsort	5000 mm	

6020 Ud- og indvendigt hjørne



Varenummer	overflade	længde	typenummer
135.6TV.100	rå	5 meter	-
135.6TV.101	elokseret	5 meter	
135.6TV.103	pulverlakeret	5 meter	
135.6TV.106	sort struktur	5 meter	
135.6TV.108	matsort	5 meter	

6020 Endebund venstre og højre

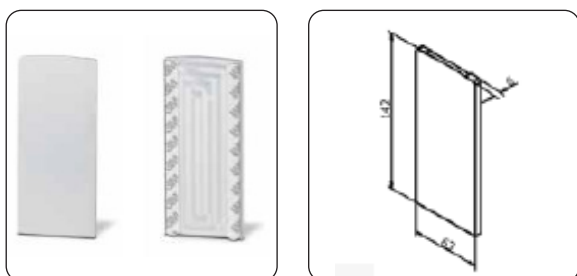

Varenummer ¹⁾	overflade	typenummer
135.6T*.100	rå	-
135.6T*.101	elokseret	
135.6T*.103	pulverlakeret	
135.6T*.106	sort struktur	
135.6T*.108	matsort	

¹⁾ *byttes ud med henholdsvis L for venstre og R for højre

6020 Endebund venstre og højre til trappe



Varenummer ¹⁾	overflade	typenummer
135.6T*.1T0	rå	-
135.6T*.1T1	elokseret	
135.6T*.1T3	pulverlakeret	
135.6T*.1T6	sort struktur	
135.6T*.1T8	matsort	

¹⁾ *byttes ud med henholdsvis L for venstre og R for højre

6020 Afstandsstykke for dræn

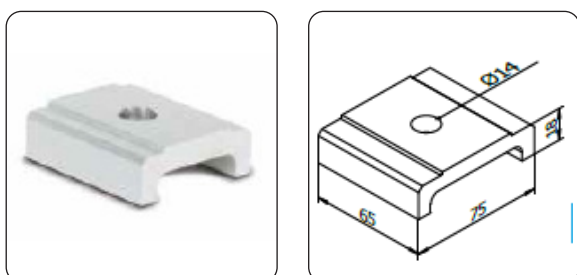

Varenummer	overflade	typenummer
135.6TA.100	rå	-
135.6TA.101	elokseret	
135.6TA.103	pulverlakeret	
135.6TA.106	sort struktur	
135.6TA.108	matsort	

6020 Samlepind for samling af to profiler

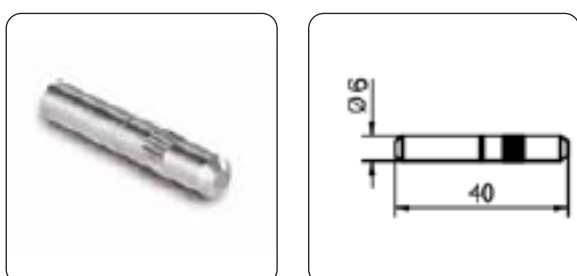

Varenummer	overflade	typenummer
135.PIN.040	rustfrit stål	-

Onlevel type 6021 1,5 kN sidemonteret i profil

- o Slankt, attraktivt design i aluminium med minimal vedligeholdelse
- o For montage af glasset bruges Onlevel Flex-fit glasmontagesystem (se side 24)
- o Integreerede drænhuller og kanal for samlepind
- o Topcover 3,0 kN tilpasningsprofiler
- o Glastykkelse fra 12 mm til 21,52 mm
- o Ekskl. glas

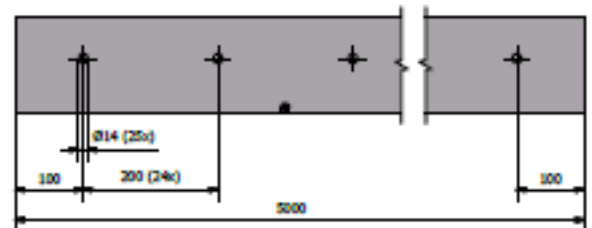
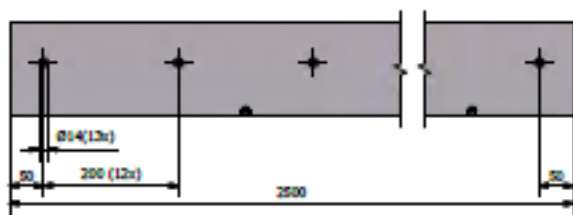
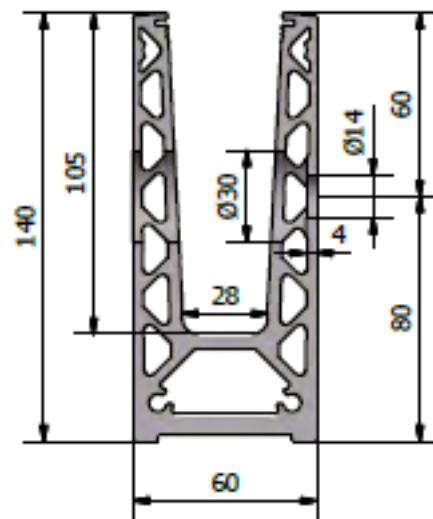
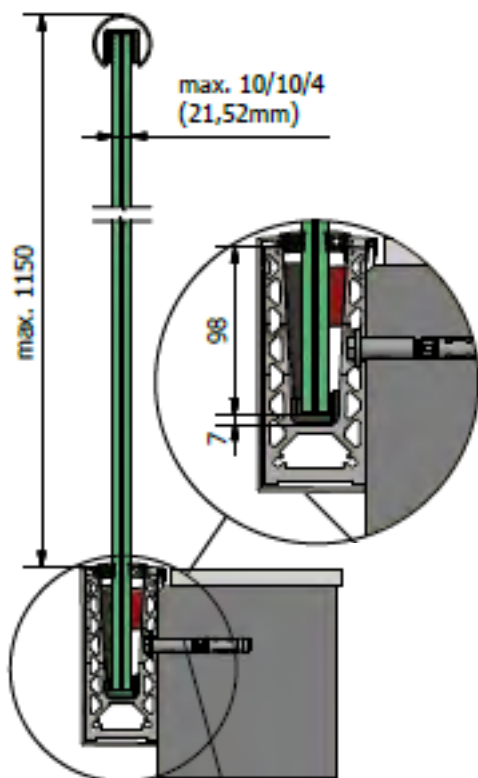

6021 Glasværnsprofil sidemonteret i profil

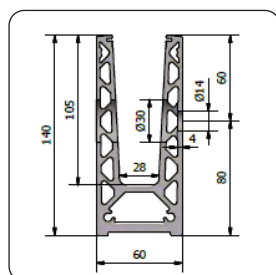
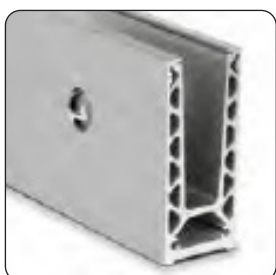

Varenummer	overflade	længde	typenummer
135.6S5.100	rå	5000 mm	-
135.6S5.101	naturelokseret	5000 mm	
135.6S5.103	pulverlakeret	5000 mm	
135.6S5.106	sort struktur	5000 mm	
135.6S5.108	matsort	5000 mm	

6021 Indvendigt hjørne

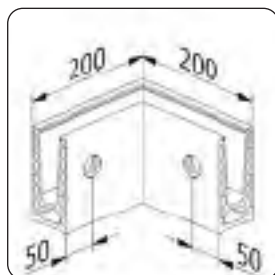

Varenummer	overflade	typenummer
135.6SI.100	rå	-
135.6SI.101	elokseret	
135.6SI.103	pulverlakeret	
135.6SI.106	sort struktur	
135.6SI.108	matsort	

6021 Udvendt hjørne

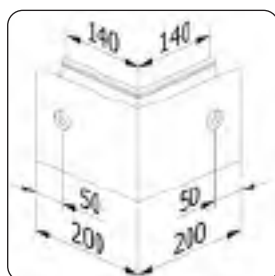

Varenummer	overflade	typenummer
135.6SU.100	rå	-
135.6SU.101	elokseret	
135.6SU.103	pulverlakeret	
135.6SU.160	sort struktur	
135.6SU.108	matsort	

6021 Dækprofil

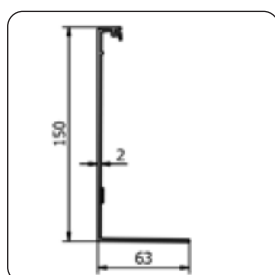

Varenummer	overflade	længde	typenummer
135.6C5.100	rå	5.000 mm	-
135.6C5.101	elokseret	5.000 mm	
135.6C5.103	pulverlakeret	5.000 mm	
135.6C5.106	sort struktur	5.000 mm	
135.6C5.108	matsort	5.000 mm	

6021 Afstandsstykke

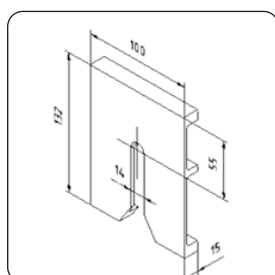

Varenummer	overflade	typenummer
135.6SA.100	rå	-
135.6SA.101	elokseret	
135.6SA.103	pulverlakeret	

6021 Dækprop og samlepind



Varenummer	dimension	farve	typenummer
135.CAP.200	Ø30 mm	hvid	-
135.CAP.201	Ø30 mm	sort	
135.CAP.205	Ø30 mm	grå	
135.PIN.000	Ø6 x 40 mm	rustfrit stål	

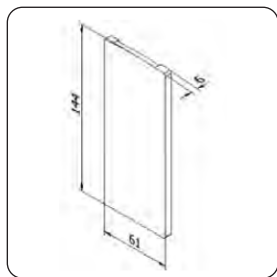

6021 Endebund venstre

Varenummer	overflade	typenummer
136.6SL.100	rå	-
136.6SL.101	naturelokseret	
136.6SL.103	RAL	



6021 Endebund højre

Varenummer	overflade	typenummer
136.6SR.100	rå	-
136.6SR.101	naturelokseret	
136.6SR.103	RAL	



6021 Endebund venstre for afdækningsprofil

Varenummer	overflade	typenummer
136.6SL.1A0	rå	-
136.6SL.1A1	naturelokseret	
136.6SL.1A3	RAL	

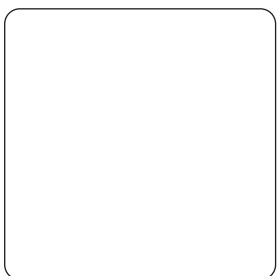

6021 Endebund højre for afdækningsprofil

Varenummer	overflade	typenummer
136.6SR.1A0	rå	-
136.6SR.1A1	naturelokseret	
136.6SR.1A3	RAL	

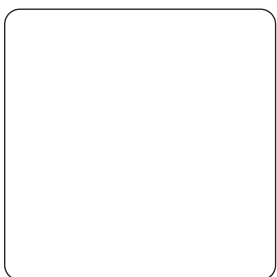

6021 Endebund venstre for trapper

Varenummer	overflade	typenummer
136.6SL.1T0	rå	-
136.6SL.1T1	naturelokseret	
136.6SL.1T3	RAL	

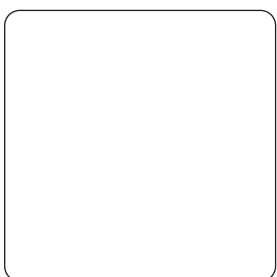

6021 Endebunde højre for trapper

Varenummer	overflade	typenummer
136.6SR.1T0	rå	-
136.6SR.1T1	naturelokseret	
136.6SR.1T3	RAL	

10



Onlevel type 6500 0,5 kN topmonteret vindskærmsprofil

- o Slankt, attraktivt design i aluminium med minimal vedligeholdelse og til brug på offentlige steder
- o For montage af glasset bruges Onlevel Flex-fit glasmontagesystem (se side 24)
- o Integreerede drænhuller og hul for samlepin
- o Glastykkelse fra 10 mm - 17,52 mm
- o Ekskl. glas

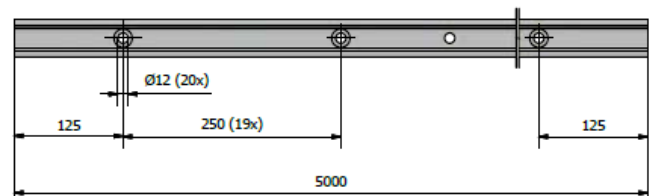
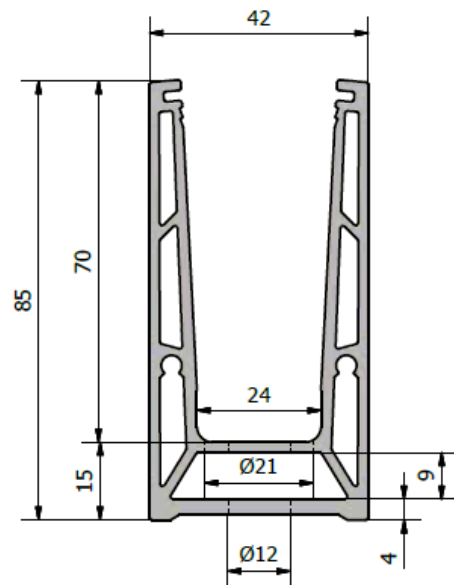
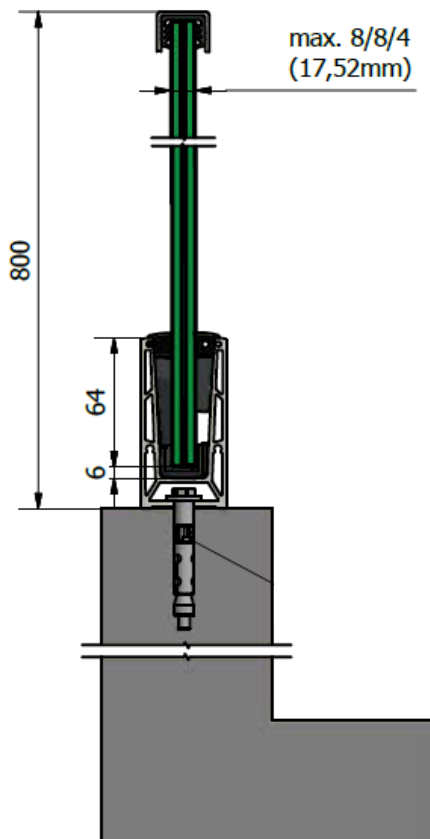

10

6500 Vindskærmsprofil

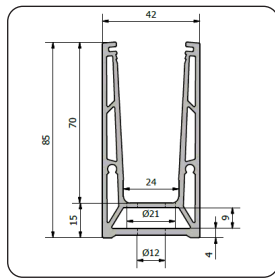

Varenummer	overflade	farve	typenummer
135.6T5.500	rå	5 meter	-
135.6T5.501	elokseret	5 meter	
135.6T5.503	pulverlakeret	5 meter	
135.6T5.506	sort struktur	5 meter	
135.6T5.508	matsort	5 meter	

6500 Ud- og indvendigt hjørne

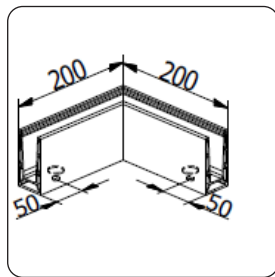

Varenummer	overflade	længde	typenummer
135.6TH.500	rå	5 meter	-
135.6TH.501	elokseret	5 meter	
135.6TH.503	pulverlakeret	5 meter	
135.6TH.506	sort struktur	5 meter	
135.6TH.508	matsort	5 meter	

6500 Endebund

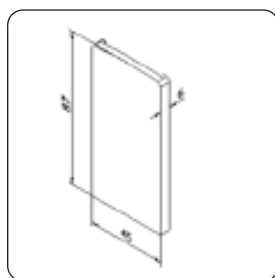

Varenummer	overflade	typenummer
135.6TE.500	rå	-
135.6TE.501	elokseret	
135.6TE.503	pulverlakeret	
135.6TE.506	sort struktur	
135.6TE.508	matsort	

6500 Samlepind

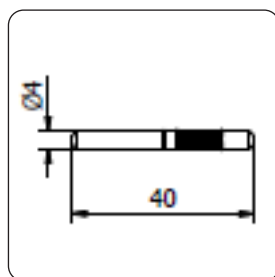

Varenummer	overflade	typenummer
135.PIN.000	rustfrit stål	-

Onlevel Topcover profiler

- o Topcover aluminiumsprofilerne giver en nem og elegant standardtilpasning til inddækning eller beklædning i alle materialer
- o Topcover profiler bruges til at usynliggøre selve værnprofilerne
- o Topcover kan hjælpe med at skjule selve værnprofilen
- o Topcover tilpasningsprofil
- o Levers også til 3,0 kN belastning.

Topcover 3 mm spalte, 0,74 kN for f.eks. tyndplade



Varenummer	længde	spalte	overflade	typenummer
135.103.5C0	5000 mm	3 mm	rå	
135.103.5C1	5000 mm	3 mm	naturelokseret	
135.103.5C3	5000 mm	3 mm	RAL	

Topcover 10 mm spalte, 0,74 kN for f.eks. glas



Varenummer	længde	spalte	overflade	typenummer
135.110.5C0	5000 mm	10 mm	rå	-
135.110.5C1	5000 mm	10 mm	naturelokseret	
135.110.5C3	5000 mm	10 mm	RAL	

Topcover 15 mm spalte, 0,74 kN for f.eks. plastplader



Varenummer	længde	spalte	overflade	typenummer
135.115.5C0	5000 mm	15 mm	rå	-
135.115.5C1	5000 mm	15 mm	naturelokseret	
135.115.5C3	5000 mm	15 mm	RAL	

Topcover 20 mm spalte, 0,74 kN for f.eks. træpaneler



Varenummer	længde	spalte	overflade	typenummer
135.120.5C0	5000 mm	20 mm	rå	-
135.120.5C1	5000 mm	20 mm	naturelokseret	
135.120.5C3	5000 mm	20 mm	RAL	

Topcover 0,74 kN for plade 120 mm for f.eks. mursten eller klinker

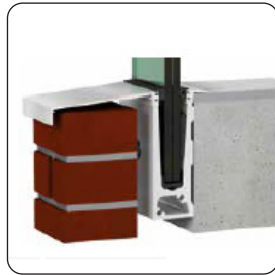
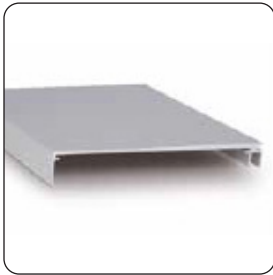

Varenummer	længde	bredde	overflade	typenummer
135.121.5C0	5.000 mm	120 mm	rå	-
135.121.5C1	5.000 mm	120 mm	naturelokseret	
135.121.5C3	5.000 mm	120 mm	RAL	

Topcover Horizontal



Varenummer	længde	bredde	overflade	typenummer
135.TCH.500	5.000 mm	20 mm	rå	-
135.TCH.501	5.000 mm	20 mm	naturelokseret	
135.TCH.503	5.000 mm	20 mm	RAL	

Topcover Floor connect



Varenummer	længde	bredde	overflade	typenummer
135.FC2.5C0	5.000 mm	20 mm	rå	-
135.FC2.5C1	5.000 mm	20 mm	naturelokseret	
135.FC2.5C3	5.000 mm	20 mm	RAL	

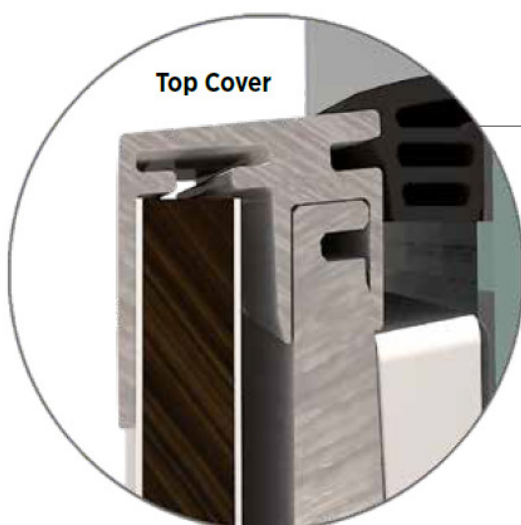

Tilbehør til OnLevel for alle typer

Flex-fit montagedele til 1,0 Kn og 1,5 Kn



Varenummer	passer til længde	glastykkelse	farve	typenummer
135.112.BLA	5.000 mm	12 mm	sort	-
135.113.RED	5.000 mm	12,76 mm	rød	
135.114.GRE	5.000 mm	13,52 mm	grå	
135.115.YEL	5.000 mm	15 mm	gul	
135.117.BRW	5.000 mm	16,76 mm	brun	
135.118.GRE	5.000 mm	17,52 mm	grøn	
135.119.BLU	5.000 mm	19 mm	blå	
135.121.RED	5.000 mm	20,76 mm	rød	
135.122.GRE	5.000 mm	21,52 mm	grøn	

Flex-Fit værktøj



Varenummer	typenummer
135.FFT.000	passer til alle størrelser

10

Combi værktøj



Varenummer	typenummer
135.COM.000	passer til alle størrelser

Forseglingsgummi



Varenummer	farve	matriale	typenummer
135.G15.000	sort	gummi	-

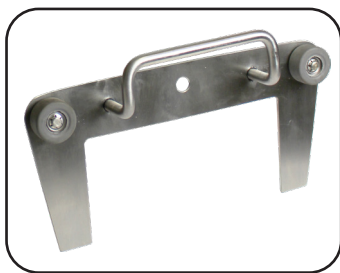

OnLevel Flex-Fit værktøj

For hurtig og perfekt justering af det enkelte glas har OnLevel udviklet det praktiske Flex-Fit værktøj. Med blot en enkelt bevægelse kan glasset justeres millimeter præcist.



Glastykkelser fra 12 til 31,52 mm

Flex-Fit kan anvendes til et bredt udvalg af glastykkelser, fra 12 mm helt op til 31,52 mm. For alle projekter fremover, hvilket sparer dig tid og omkostninger.

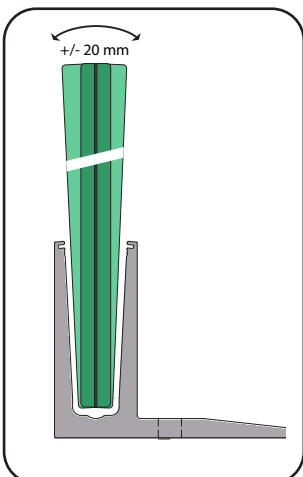

Enkel og præcis justering

OnLevel Flex-Fit er løsningen til perfekt, hurtig og sikker justering af glasværn. Med en enkelt trinløs bevægelse justerer du glasset præcist op til +/- 20 mm og reducerer montagetiden med omkring 30%.

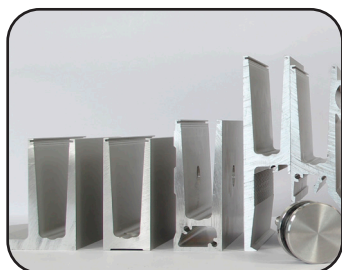

Bruges til alle OnLevel værnprofiler

Flex-Fit leveres som standard til alle OnLevel værnprofiler, så du fremover vil kunne anvende samme løsning til alle projekter, dagligdags såvel som de mere udfordrende. Du får alle fordelene, herunder justeringsnøjagtighed, håndtering fra indvendig side samt Flex-Fit værktøjets brugervenlighed.

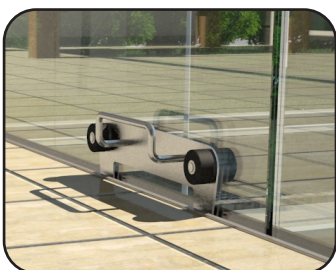

Håndteres fra indvendig side

Udover at reducere montagetiden med 30%, har det unikke Flex-Fit system flere fordele at byde på. I modsætning til traditionelle systemer, hvor du er nødt til at arbejde på begge sider af glasset, håndteres Flex-Fit fra den indvendige side. På denne måde sparer du tid og udgifter til stillads eller lift, samtidig med at arbejdet udføres mere sikkert.

Glasstop

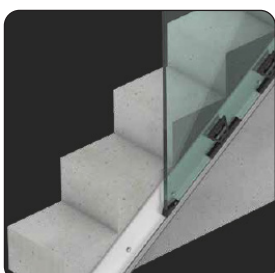

Varenummer	farve	materiale	typenummer
135.S55.140	sort	plast	-





Balystre rustfrit stål

Produktoversigt 4

Stolper:

- Runde stolper* 28
- Runde sidehægte stolper* 32
- Runde stolper til trappe* 30
- Runde sidehængte stolper f.trappe* . . 34
- Firkantet stolper* 29
- Firkantet sidehængte stolper* 33
- Firkantet stolper til trappe* 31
- Firkantet sidehængte stolper f.trappe* 31



Balustre rundrør Ø42,4 mm topmonteret

- o Inklusiv D-formet klembeslag med indlæg.
- o Glastykkelse fra 8 - 12,76 mm
- o Kan fås til håndliste eller med endebund

Vi lagerfører ikke disse produkter. For prisgivning har vi behov for, at du besvarer følgende spørgsmål :

Mål på H: 1000 mm _____ 1100 mm _____ 1200 mm _____

Materiale: AISI 304 (indendørs) _____

AISI 316 (udendørs) _____

Antal endebalustre: venstre/højre (set udefra)

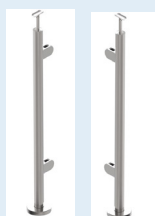

Antal: _____ højre

Antal: _____ venstre

Antal midterbalustre 180 grader



Antal: _____

Antal hjørnebalustre (kan vendes til ind- og udvendig)



Antal: _____

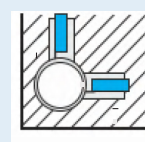
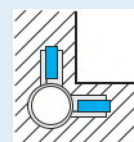

Glastykkelse: 8 mm _____, 8,76mm _____,

10mm _____, 10,76 mm _____.

Hvilken endeaflutning:

For håndliste _____

eller _____

med endebund _____

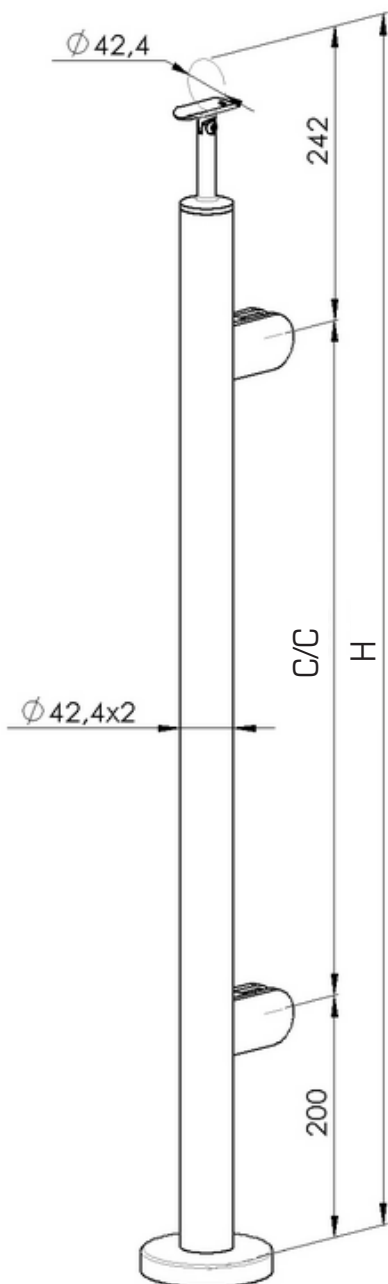

H	C/C
1000 mm	558 mm
1100 mm	658 mm
1200 mm	758 mm

10

Balustre firkantet 40 x 40 mm topmonteret

- o Inklusiv firkantet klembeslag med indlæg.
- o Glastykkelse fra 8 - 12,76 mm
- o Udføres i rustfrit stål AISI 304 og 316
- o Inklusiv firkantet klembeslag med indlæg.
- o Kan fås til håndliste eller med topendebund

Vi lagerfører ikke disse produkter. For prisgivning har vi behov for, at du besvarer følgende spørgsmål :

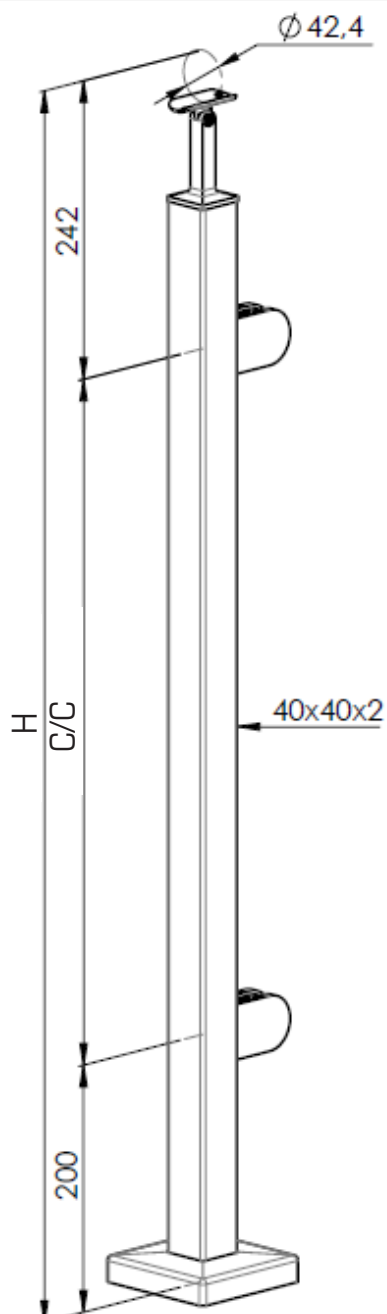

H	C/C
1000 mm	558 mm
1100 mm	658 mm
1200 mm	758 mm

Mål på H: 1000 mm _____ 1100 mm _____ 1200 mm _____

Materiale: AISI 304 (indendørs) _____

AISI 316 (udendørs) _____

Antal endebalustre: venstre/højre (set udefra)

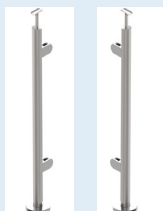

Antal: _____ højre

Antal: _____ venstre

Antal midterbalustre 180 grader



Antal: _____

Antal hjørnebalustre (kan vendes til ind- og udvendig)



Antal: _____

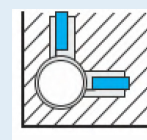
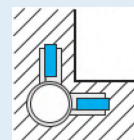

Glastykkelse: 8 mm _____, 8,76mm _____,

10mm _____, 10,76 mm _____.

Hvilken endeafslutning:

For håndliste

eller

med endebund



Balustre rundrør Ø42,4 mm topmonteret for trapper

- o Inklusiv D-formet klembeslag med indlæg.
- o Glastykkelse fra 8 - 12,76 mm
- o Kan fås til håndliste eller med endebund

Vi lagerfører ikke disse produkter. For prisgivning har vi behov for, at du besvarer følgende spørgsmål :

Mål på H: 1000 mm _____ 1100 mm _____ 1200 mm _____

Materiale: AISI 304 (indendørs) _____

AISI 316 (udendørs) _____

Antal endebalustre: venstre/højre (set udefra)

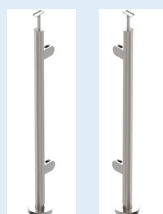

Antal: _____ højre

Antal: _____ venstre

Antal midterbalustre 180 grader



Antal: _____

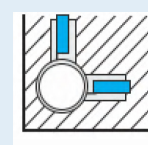
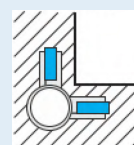

Antal hjørnebalustre (kan vendes til ind- og udvendig)



Antal: _____

Glastykkelse: 8 mm _____, 8,76mm _____,

10mm _____, 10,76 mm _____.

Hvilken endefslutning:

For håndliste _____

eller _____

med endebund _____

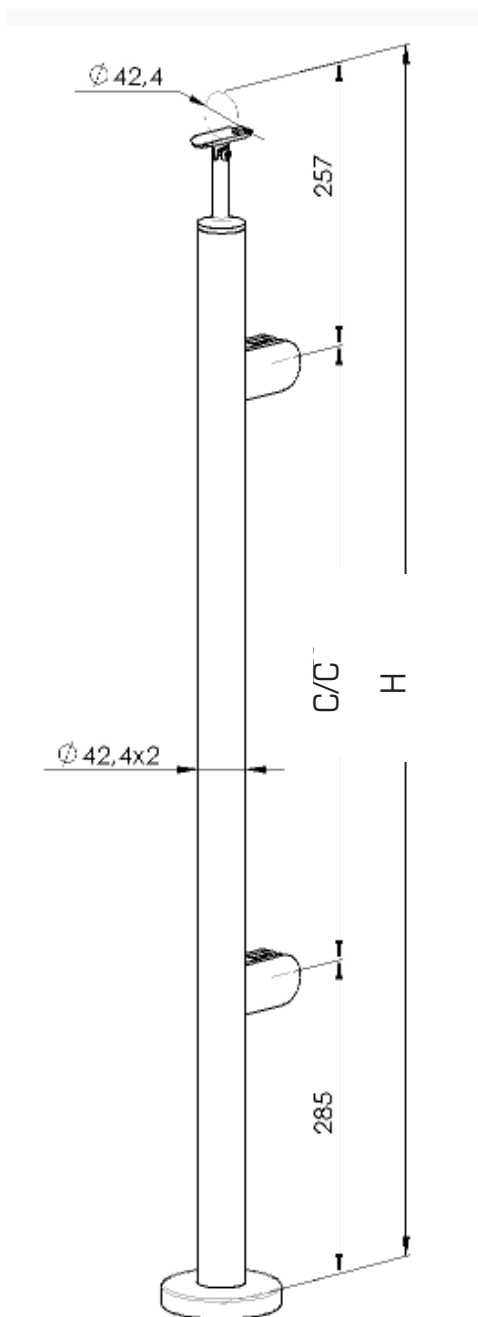

H	C/C
1000 mm	458 mm
1100 mm	558 mm
1200 mm	658 mm

10

Balustre firkantet 40 x 40 mm rør topmonteret til trapper

- o Inklusiv firkantet klembeslag med indlæg.
- o Glastykkelse fra 8 - 12,76 mm
- o Kan fås til håndliste eller med endebund

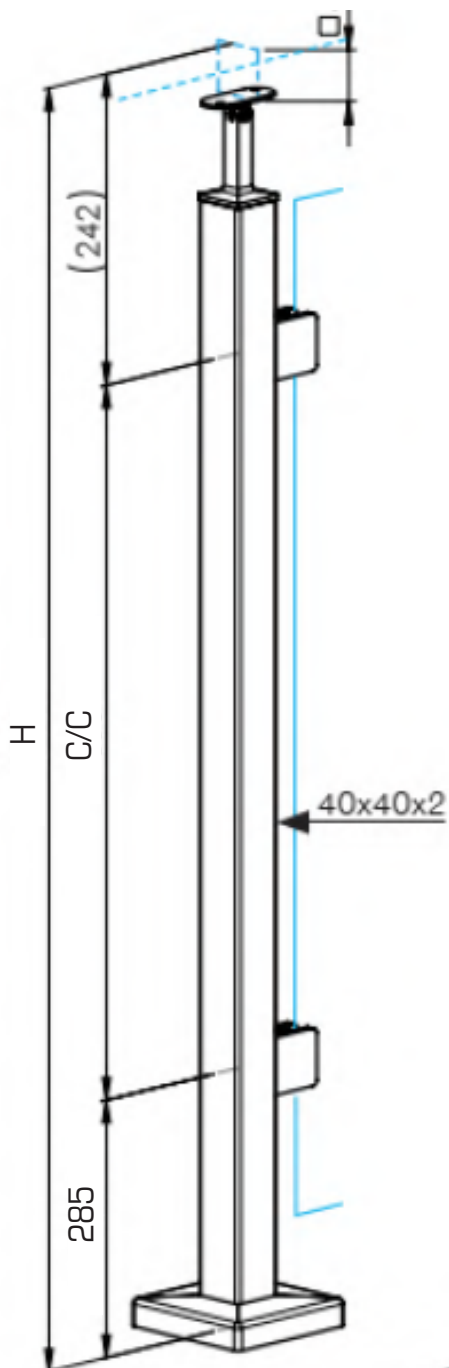

H	C/C
1000 mm	458 mm
1100 mm	558 mm
1200 mm	658 mm

Vi lagerfører ikke disse produkter. For prisgivning har vi behov for, at du besvarer følgende spørgsmål :

Mål på H: 1000 mm ___ 1100 mm ___ 1200 mm ___

Materiale: AISI 304 (indendørs) ___

AISI 316 (udendørs) ___

Antal endebalustre: venstre/højre (set udefra)

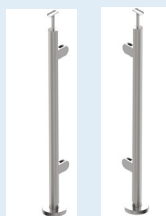

Antal: ___ højre

Antal: ___ venstre

Antal midterbalustre 180 grader



Antal: ___

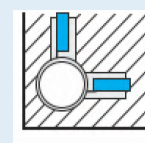
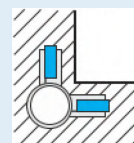

Antal hjørnebalustre (kan vendes til ind- og udvendig)



Antal: ___

Glastykkelse: 8 mm ___ , 8,76mm ___ ,

10mm ___ , 10,76 mm ___ .

Hvilken endefslutning:

For håndliste

eller

med endebund





Balustre rundrør Ø42,4 mm sidemonteret

- o Inklusiv D-formet klembeslag med indlæg.
- o Glastykkelse fra 8 - 12,76 mm
- o Kan fås til håndliste eller med endebund

Vi lagerfører ikke disse produkter. For prisgivning har vi behov for, at du besvarer følgende spørgsmål :

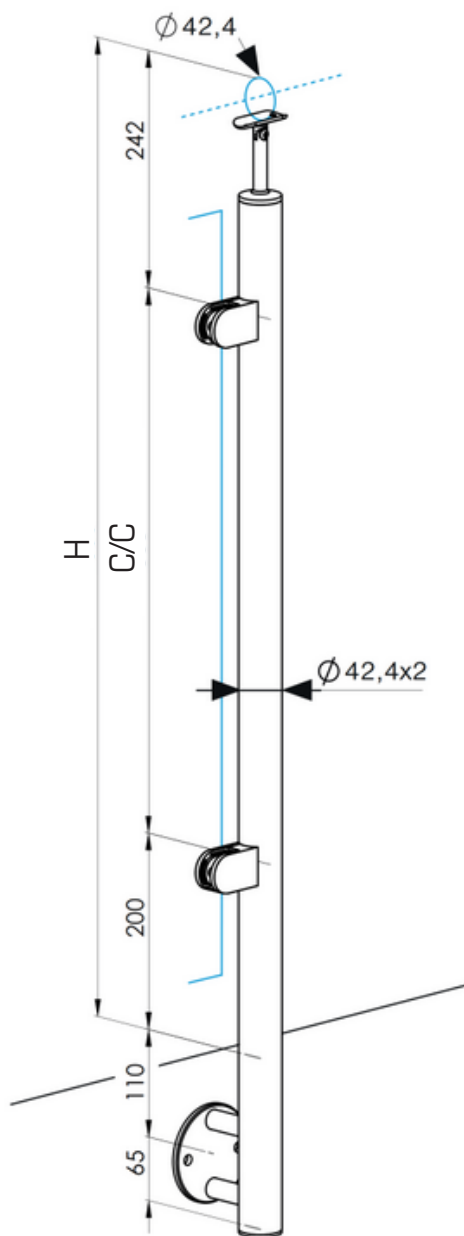

Mål på H: 1000 mm _____ 1100 mm _____ 1200 mm _____

Materiale: AISI 304 (indendørs) _____

AISI 316 (udendørs) _____

Antal endebalustre: venstre/højre (set udefra)



Antal: _____ højre

Antal: _____ venstre

Antal midterbalustre 180 grader



Antal: _____

Antal hjørnebalustre (kan vendes til ind- og udvendig)



Antal: _____

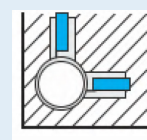
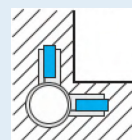

Glastykkelse: 8 mm _____, 8,76mm _____,

10mm _____, 10,76 mm _____.

Hvilken endeafslutning:

For håndliste

eller

med endebund



H	C/C
1000 mm	558 mm
1100 mm	658 mm
1200 mm	758 mm

Balustre firkantet rør 40 x 40 mm sidemonteret

- o Inklusiv firkantet klembeslag med indlæg.
- o Glastykkelse fra 8 - 12,76 mm
- o Kan fås til håndliste eller med endebund

Vi lagerfører ikke disse produkter. For prisgivning har vi behov for, at du besvarer følgende spørgsmål :

Mål på H: 1000 mm _____ 1100 mm _____ 1200 mm _____

Materiale: AISI 304 (indendørs) _____

AISI 316 (udendørs) _____

Antal endebalustre: venstre/højre (set udefra)



Antal: _____ højre

Antal: _____ venstre

Antal midterbalustre 180 grader



Antal: _____

Antal hjørnebalustre (kan vendes til ind- og udvendig)



Antal: _____

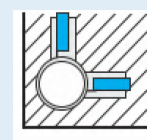
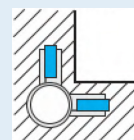

Glastykkelse: 8 mm _____, 8,76mm _____,

10mm _____, 10,76 mm _____.

Hvilken endeafslutning:

For håndliste _____

eller _____

med endebund _____

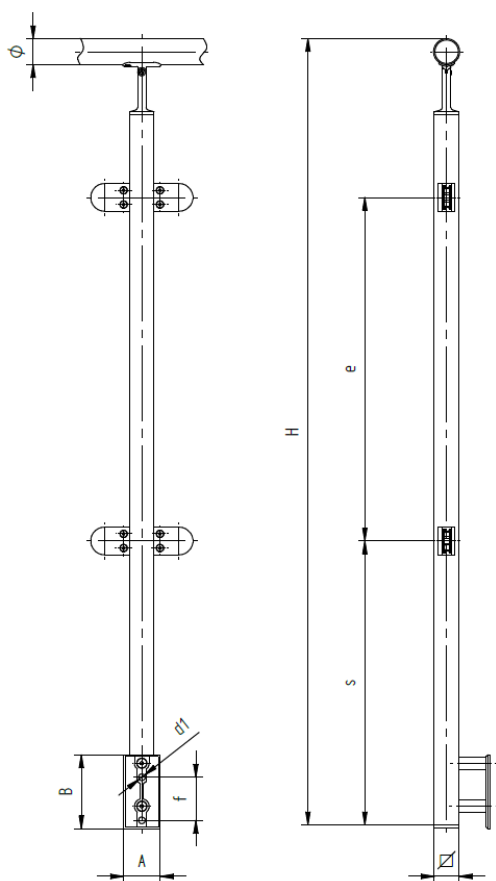

H	e	s
1000 mm	558 mm	375 mm
1100 mm	658 mm	375 mm
1200 mm	758 mm	375 mm

Balustre rundrør Ø42,4 mm sidehængt for trapper

- o Inklusiv D-formet klembeslag med indlæg.
- o Glastykkelse fra 8 - 12,76 mm
- o Kan fås til håndliste eller med endebund

Vi lagerfører ikke disse produkter. For prisgivning har vi behov for, at du besvarer følgende spørgsmål :

Mål på H: 1000 mm ____ 1100 mm ____ 1200 mm ____

Materiale: AISI 304 (indendørs) ____
AISI 316 (udendørs) ____

Antal endebalustre: venstre/højre (set udefra)



Antal: ____ højre
 Antal: ____ venstre

Antal midterbalustre 180 grader



Antal: ____

Hvormange hjørnebalustre (kan vendes til ind- og udvendig)



Antal: ____

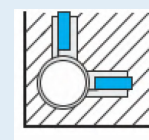
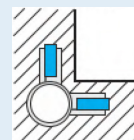

Glastykkelse: 8 mm ____, 8,76mm ____,
10mm ____, 10,76 mm __.

Hvilken endeafslutning:

For håndliste

eller

med endebund





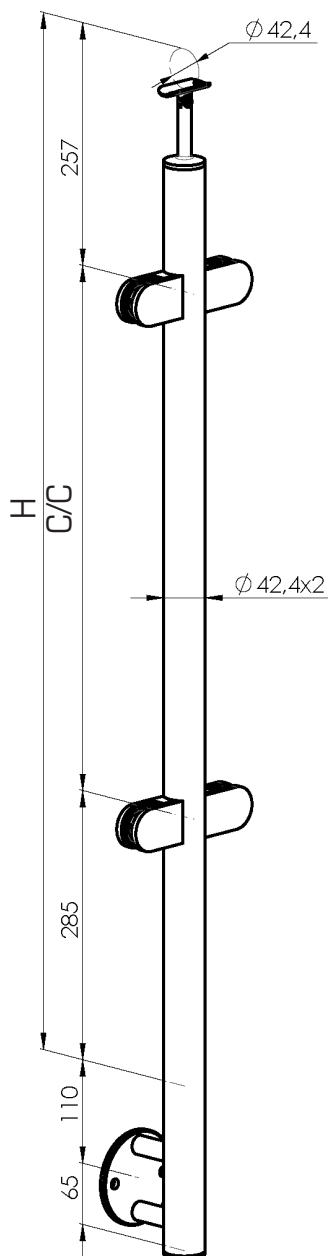

H	C/C
1000 mm	458 mm
1100 mm	558 mm
1200 mm	658 mm

10

Balustre firkantet rør 40 x 40 mm sidehængt for trapper

- o Inklusiv firkantet klembeslag med indlæg.
- o Glastykkelse fra 8 - 12,76 mm
- o Kan fås til håndliste eller med endebund

Vi lagerfører ikke disse produkter. For prisgivning har vi behov for, at du besvarer følgende spørgsmål :

Mål på H: 1000 mm _____ 1100 mm _____ 1200 mm _____

Materiale: AISI 304 (indendørs) _____
AISI 316 (udendørs) _____

Antal endebalustre: venstre/højre (set udefra)



Antal: _____ højre

Antal: _____ venstre

Antal midterbalustre 180 grader



Antal: _____

Hvormange hjørnebalustre (kan vendes til ind- og udvendig)



Antal: _____

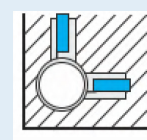
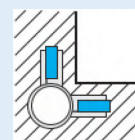

Glastykkelse: 8 mm _____, 8,76mm _____,
10mm _____, 10,76 mm _____.

Hvilken endeafslutning:

For håndliste

eller

med endebund





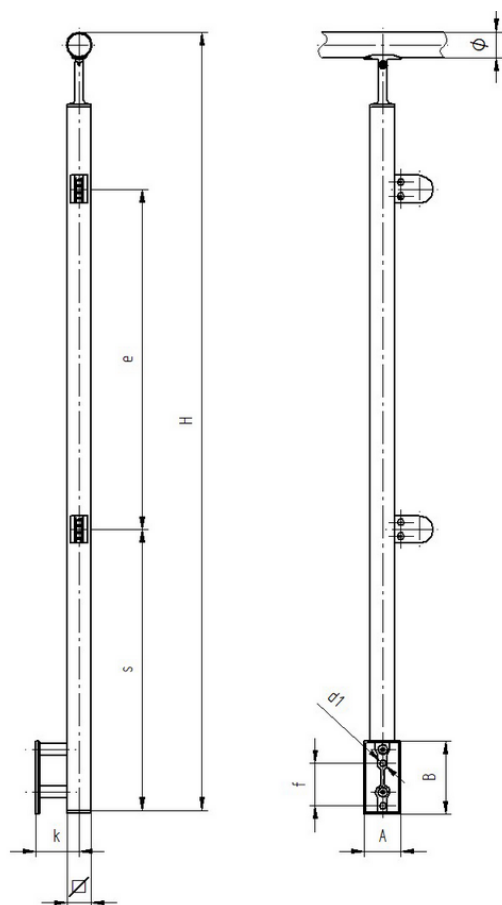

H	e	s
1000 mm	458 mm	460 mm
1100 mm	558 mm	460 mm
1200 mm	658 mm	460 mm





Håndliste

Produktoversigt 4

U-profiler:

Aluminium 38

Rustfri stål 42

Rundprofil:

Aluminium 40

Rustfri stål 44

Rundrør:

Rustfrit stål 46

Tilbehør 47

OnLevel

OnLevel er en specialiseret producent af indespændt værn, som fås i mange forskellige typer og som kan dække ethvert behov. Deres kendte Flex-Fit system udmærker sig ved, at et værktøj kan bruges til alle typer af deres profiler, og kan justere glasset millimeter præcist fra den indvendige side. OnLevel har altid bevidst prøvet på at reducere montagetiden ved nybyggeri.

Håndliste U-profil 26 mm aluminium

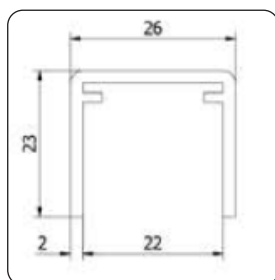

Varenummer	overflade	længde	typenummer
135.U26.A40	rå	5000 mm	-
135.U26.A41	naturelokseret	5000 mm	
135.U26.A43	RAL	5000 mm	
135.U26.A46	sort struktur	5000 mm	
135.U26.A48	matsort	5000 mm	

Håndliste U-profil 30 mm aluminium

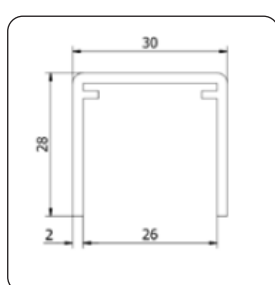

Varenummer	overflade	længde	typenummer
135.U26.A40	rå	5000 mm	-
135.U26.A41	naturelokseret	5000 mm	
135.U26.A43	RAL	5000 mm	
135.U26.A46	sort struktur	5000 mm	
135.U26.A48	matsort	5000 mm	

Håndliste U-profil 42 mm aluminium

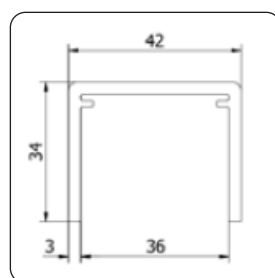

Varenummer	overflade	længde	typenummer
135.U36.A40	rå	5000 mm	-
135.U36.A41	naturelokseret	5000 mm	
135.U35.A43	RAL	5000 mm	
135.U36.A46	sort struktur	5000 mm	
135.U36.A48	matsort	5000 mm	

Forbinderstykke til U-håndlisteprofil

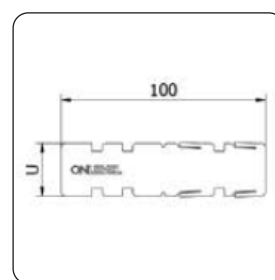

Varenummer	overflade	type	typenummer
135.U2S.000	rå aluminium	22 mm	-
135.U3S.000	rå aluminium	26 mm	
135.U4S.000	rå aluminium	36 mm	

Forbinderstykker 90° til U-håndlisteprofil

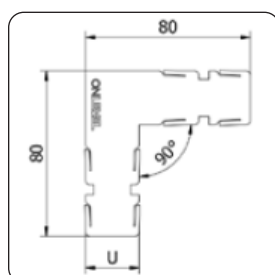
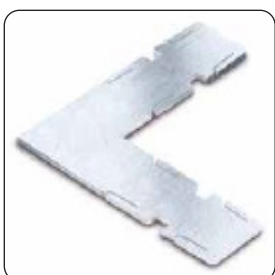

Varenummer	overflade	type	typenummer
135.V2S.000	rå aluminium	22 mm	-
135.V3S.000	rå aluminium	26 mm	
135.V4S.000	rå aluminium	36 mm	

10

Endebund for U-håndlisteprofiler i aluminium

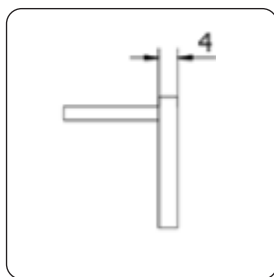

Varenummer	overflade	type	typenummer
135.E26.000	rå	26 mm	-
135.E26.001	naturelokseret	26 mm	
135.E26.003	RAL farvet	26 mm	
135.E30.000	rå	30 mm	
135.E30.001	naturelokseret	30 mm	
135.E30.003	RAL farvet	30 mm	
135.E40.000	rå	42 mm	
135.E40.001	naturelokseret	42 mm	
135E40.003	RAL farvet	42 mm	

Vægbeslag for U-håndlisteprofiler i aluminium

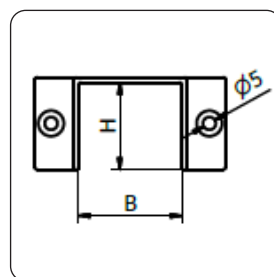

Varenummer	overflade	type	typenummer
135.V26.000	rå	26 mm	-
135.V26.001	naturelokseret	26 mm	
135.V26.003	RAL farvet	26 mm	
135.V30.000	rå	30 mm	
135.V30.001	naturelokseret	30 mm	
135.V30.003	RAL farvet	30 mm	
135.V40.000	rå	42 mm	
135.V40.001	naturelokseret	42 mm	
135.V40.003	RAL farvet	42 mm	

10

Hjørnesamling 90° til U-håndlisteprofiler aluminium

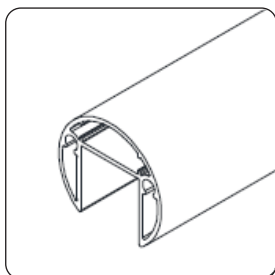

Varenummer	overflade	type	typenummer
135.H26.000	rå	26 mm	-
135.H26.001	naturelokseret	26 mm	
135.H26.003	RAL farvet	26 mm	
135.H30.000	rå	30 mm	
135.H30.001	naturelokseret	30 mm	
135.H30.003	RAL farvet	30 mm	
135.H40.000	rå	42 mm	
135.H40.001	naturelokseret	42 mm	
135.H40.003	RAL farvet	42 mm	

Håndliste aluminium Ø42,4 mm

Varenummer	overflade	længde	typenummer
134.858.560	rå	6100 mm	-
134.858.561	naturelokseret	6100 mm	
134.858.565	sortmalet	6100 mm	

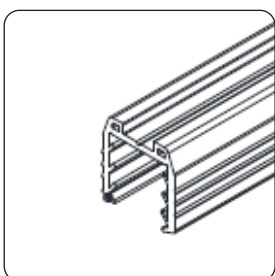
Indlægsgummi til aluminiumshåndliste

Varenummer	længde	glastykkelse	typenummer
134.418.511	6100 mm	12,76	-
134.418.512	6100 mm	16,76	
134.418.514	6100 mm	21,52	

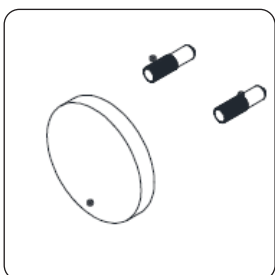
Endebund til aluminiumshåndliste

Varenummer	overflade	typenummer
134.E42.200	rå	-
134.E42.203	naturelokseret	
134.E42.250	sortmalet	
134.418.500	bolt for endebund	

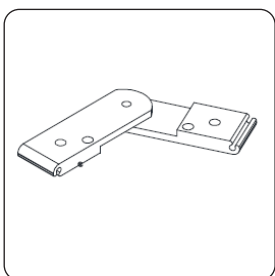
Vinkelsamled til aluminiumshåndlisteprofilen

Varenummer	materiale	typenummer
134.404.836	aluminium	-



HANSEN LELLINGE

| Glas- og dørteknik |

Diamantek	s.	7
Dorma Glas	s.	29
Normbau	s.	33
Randi	s.	38
d line	s.	42
Andre	s.	45

9. DØRHANKE

Hansen Lellinge A/S er leverandør for alt inden for glasmontage. Vi kan hjælpe med rådgive og finde de rette beslag til din glasdørsløsning, alt efter dine ønsker og behov.

I dette katalog præsenterer vi de standard dørhanke som er mest anvendte, mange af disse dørhanke bliver også lagerført på vores lager i Taastrup.

Vort katalog over U-hanke, T-hanke og mange andre former og i mange forskellige overflader.

Håndliste U-profil 26 mm rustfrit stål

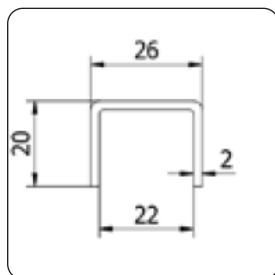

Varenummer ¹⁾	AISI	længde	typenummer
135.U26.421	304	5000 mm	-
135.U26.431	316	5000 mm	

¹⁾ Indlægsgummi se side 43

Håndliste U-profil 26 mm rustfrit stål

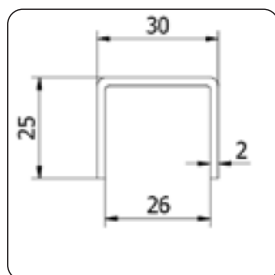

Varenummer ¹⁾	AISI	længde	typenummer
135.U30.421	304	5000 mm	-
135.U30.431	316	5000 mm	

¹⁾ Indlægsgummi se side 43

Håndliste U-profil 26 mm rustfrit stål

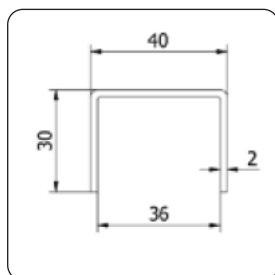

Varenummer ¹⁾	AISI	længde	typenummer
135.U40.421	304	5000 mm	-
135.U40.431	316	5000 mm	

¹⁾ Indlægsgummi se side 43

Endestykke for U-profil rustfrit stål

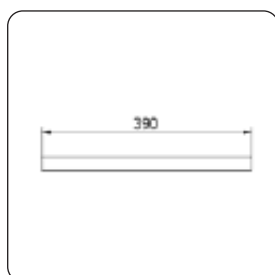

Varenummer	AISI	længde	typenummer
135.S26.E21	304	390 mm	-
135.S26.E31	316	390 mm	
135.U30.E21	304	390 mm	
135.U30.E31	316	390 mm	
135.U40.E21	304	390 mm	
135.U40.E31	316	390 mm	

Forbinder 90° for U-profil rustfrit stål

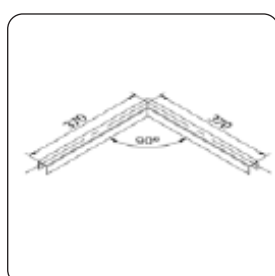

Varenummer	AISI	længde	typenummer
135.S26.E21	304	383 mm	-
135.S26.E31	316	383 mm	
135.U30.E21	304	385 mm	
135.U30.E31	316	385 mm	
135.U40.E21	304	390 mm	
135.U40.E31	316	390 mm	

10

Gummiliste for U-håndlisteprofil 26/22 mm aluminium og rustfrit stål

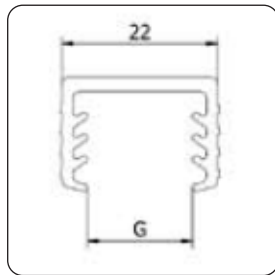

Varenummer	glastykkelse	længde	typenummer
135.22U.408	8-11 mm	5000 mm	-
135.22U.411	11,5-13,5 mm	5000 mm	
135.22U.415	15 mm	5000 mm	
135.22U.416	16-17,5 mm	5000 mm	

Gummiliste for U-håndlisteprofil 30/26 mm aluminium og rustfrit stål

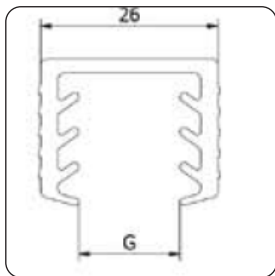

Varenummer	glastykkelse	længde	typenummer
135.22U.408	8-11 mm	5000 mm	-
135.22U.411	11,5-13,5 mm	5000 mm	
135.22U.415	15 mm	5000 mm	
135.22U.416	16-17,5 mm	5000 mm	
135.26U.419	19 mm	5000 mm	
135.26U.420	20 - 21,5 mm	5000 mm	

Gummiliste for U-håndlisteprofil 40/36 mm aluminium og rustfrit stål

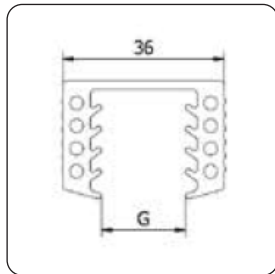

Varenummer	glastykkelse	længde	typenummer
135.36U.420	20,5 - 21,5 mm	5000 mm	-
135.36U.424	24,5 - 25,5 mm	5000 mm	
135.36U.430	30,5 - 31,5 mm	5000 mm	

Håndliste rund Ø42,4 mm rustfri

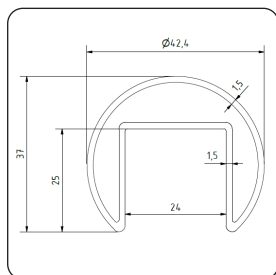

Varenummer	AISI	længde	typenummer
135.R42.521	304	5000 mm	-
135.R42.531	316	5000 mm	-

Gummi for håndliste Ø42,4 mm

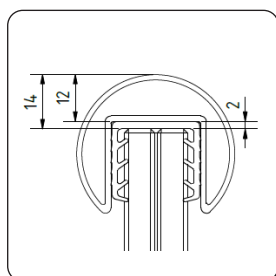

Varenummer	glastykkelse	længde	typenummer
135.24R.508	8 - 11 mm	5000 mm	-
135.24R.511	11,5 - 13,5 mm	5000 mm	-
135.24R.515	15 mm	5000 mm	-
135.24R.516	16 - 17,5 mm	5000 mm	-
135.24R.519	19 mm	5000 mm	-
135.24R.520	20 - 21,5 mm	5000 mm	-

10

Endebund for Ø42,4 håndliste

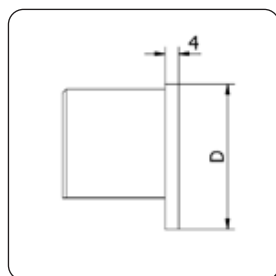

Varenummer	AISI	typenummer
135.R42.E21	304	-
135.R42.E31	316	-

Forbindelsesstykke for Ø42,4 håndliste

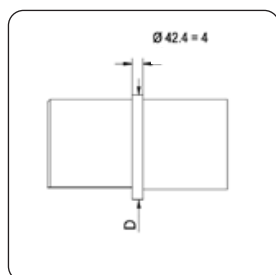

Varenummer	AISI	typenummer
135.R42.S21	304	-
135.R42.S31	316	-

Hjørnesamling 90° for Ø42,4 håndliste

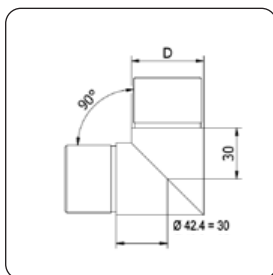

Varenummer	AISI	typenummer
135.R42.S21	304	-
135.R42.S31	316	-

Vægholder for Ø42,4 håndliste

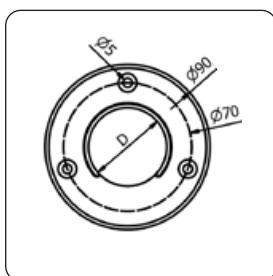

Varenummer	AISI	typenummer
135.R42.H21	304	-
135.R42.H31	316	-

Vinkelsamling for Ø42,4 håndliste

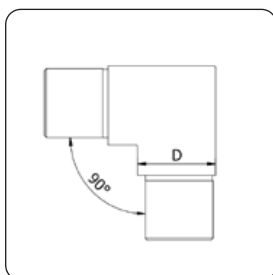

Varenummer	AISI	typenummer
135.R42.????	304	-
135.R42.????	316	-

Samleled opadgående justerbart for håndliste Ø42,4 mm

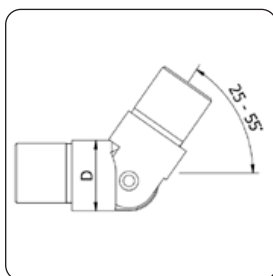

Varenummer	AISI	typenummer
135.R42.021	304	-
135.R42.031	316	-

Samleled nedadgående justerbart for håndliste Ø42,4 mm

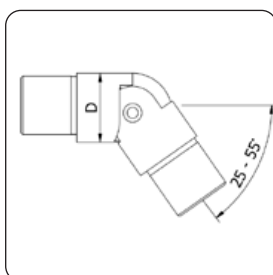

Varenummer	AISI	typenummer
135.R42.N21	304	-
135.R42.N31	316	-

Håndlisterør Ø42,4 mm

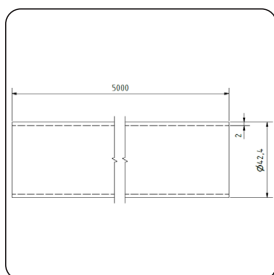

Varenummer	AISI	længde	typenummer
135.42R.521	304	5000 mm	
135.42R.531	316	5000 mm	

Endebund flad for håndlisterør Ø42,4 mm

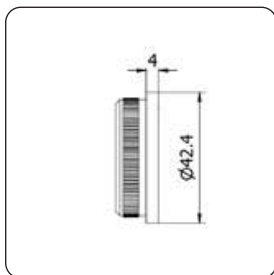

Varenummer	AISI	typenummer
135.42R.E21	304	-
135.42R.E31	316	

Endebund med buet ende for håndliste Ø42,4 mm

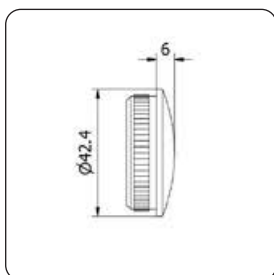

Varenummer	AISI	typenummer
135.42R.B21	304	-
135.42R.B31	316	

Forbindelsesstykke for håndliste 42,4 mm

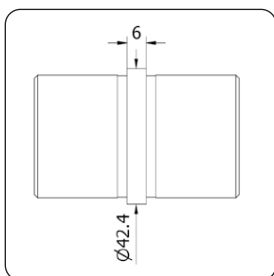

Varenummer	AISI	typenummer
135.42R.S21	304	-
135.42R.S31	316	

Vinkelsamling for håndliste 42,4 mm

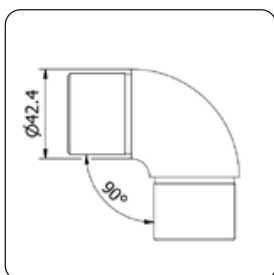

Varenummer	AISI	typenummer
135.42R.V21	304	-
135.42R.V31	316	

10

Holder til glas for håndliste Ø42.4 mm

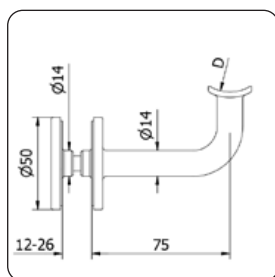

Varenummer	AISI	typenummer
135.42R.G21	304	-
135.42R.G31	316	-

Vægholder for håndliste Ø42.4 mm

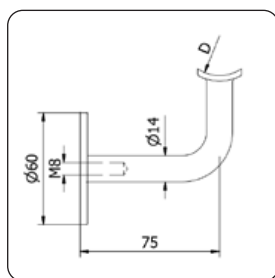

Varenummer	AISI	typenummer
135.42R.H21	304	-
135.42R.H31	316	-



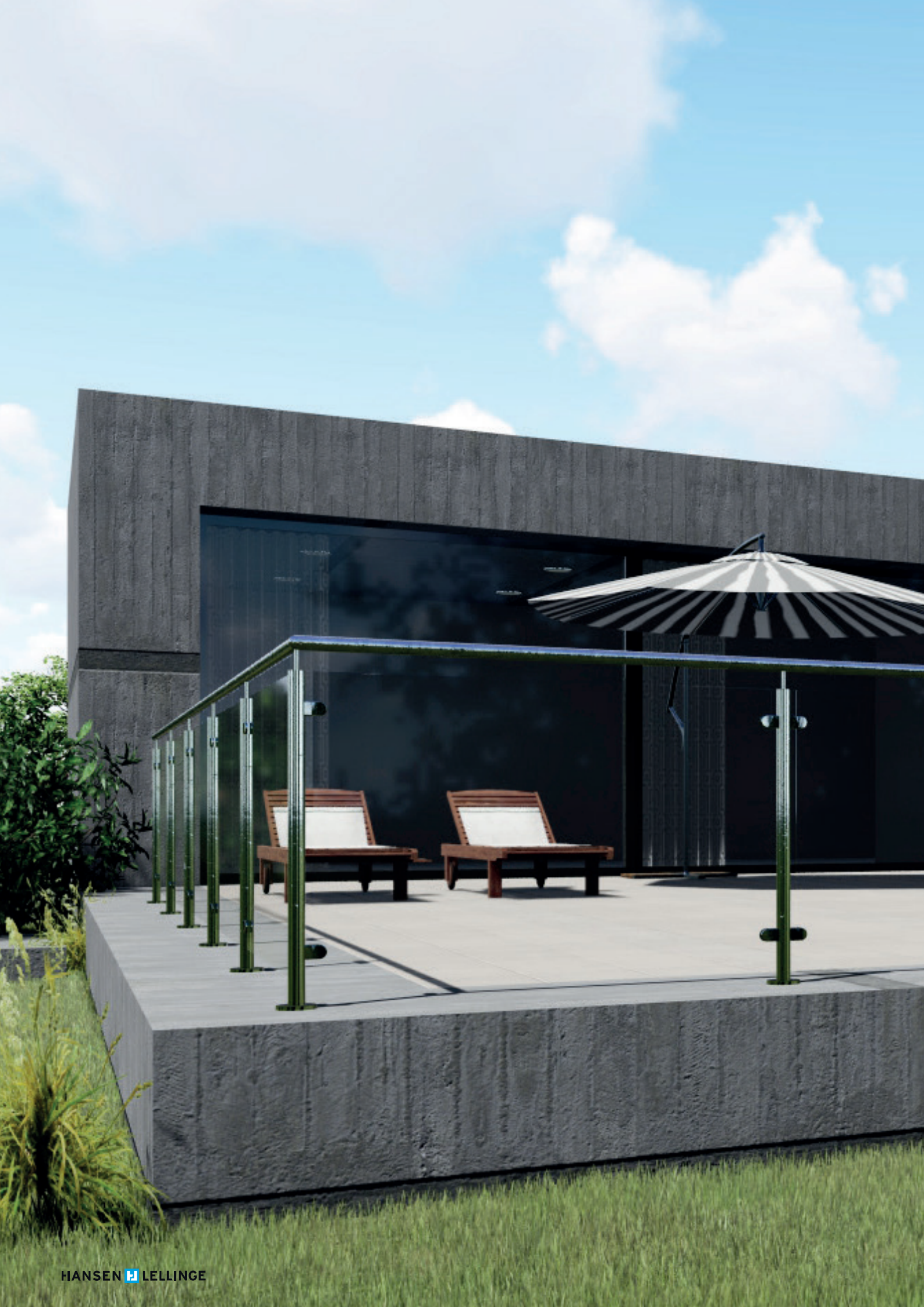



Klembeslag

Produktoversigt 4

Klembeslag:

D-formet 50

Firkantet 59

Runde 67

Specielle 74

Pauli

Pauli + Sohn leverer et bredt sortiment af beslag og løsninger til montage af glas til ind- og udvendigt byggeri. Pauli har de senere år markeret sig kraftigt med designrigtige beslag til bygninger. Mange af beslagene er med Tysk Nationale tekniske godkendelse for byggeri.

Klemleslag 4808/4810/4812 zink, D-form flad ende

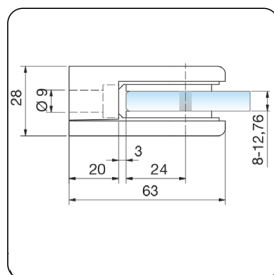
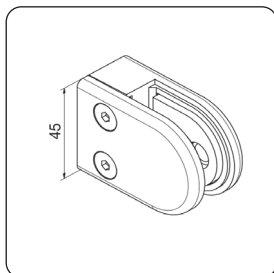

Varenummer	for glas	overflade	ende	rør	typenummer
120.480.8ZN.000	8-8,76 mm	rå zink	flad		-
120.480.8ZN.100	8-8,76 mm	matkrom	flad		
120.480.8ZN.500	8-8,76 mm	krom	flad		
120.480.8ZN.120	8-8,76 mm	grå	flad		
120.480.8ZN.140	8-8,76 mm	hvid	flad		
120.480.8ZN.160	8-8,76 mm	sort	flad		
120.480.8ZN.22K	8-8,76 mm	RS klarlak	flad		
120.481.0ZN.000	10-10,76 mm	rå zink	flad		
120.481.0ZN.100	10-10,76 mm	matkrom	flad		
120.481.0ZN.500	10-10,76 mm	krom	flad		
120.481.0ZN.120	10-10,76 mm	grå	flad		
120.481.0ZN.140	10-10,76 mm	hvid	flad		
120.481.0ZN.160	10-10,76 mm	sort	flad		
120.481.0ZN.22K	10-10,76 mm	RS klarlak	flad		
120.481.2ZN.000	12-12,76 mm	rå zink	flad		
120.481.2ZN.100	12-12,76 mm	matkrom	flad		
120.481.2ZN.500	12-12,76 mm	krom	flad		
120.481.2ZN.120	12-12,76 mm	grå	flad		
120.481.2ZN.140	12-12,76 mm	hvid	flad		
120.481.2ZN.160	12-12,76 mm	sort	flad		
120.481.2ZN.22K	12-12,76 mm	RS klarlak	flad		

10

Klemleslag rustfrit stål VA2 (ANSI304)/VA4 (ANSI 316)



Varenummer	for glas	overflade	ende	AISI	typenummer
120.930.6VA.200	8/8,76 mm	rustfrit stål	flad	304	-
120.930.7VA.200	10/10,76 mm	rustfrit stål	flad	304	
120.930.8VA.200	12/12,75 mm	rustfrit stål	flad	304	
120.930.2VA.400	8/8,76 mm	rustfrit stål	flad	316	
120.930.3VA.400	10/10,76 mm	rustfrit stål	flad	316	
120.930.4VA.400	12/12,75 mm	rustfrit stål	flad	316	

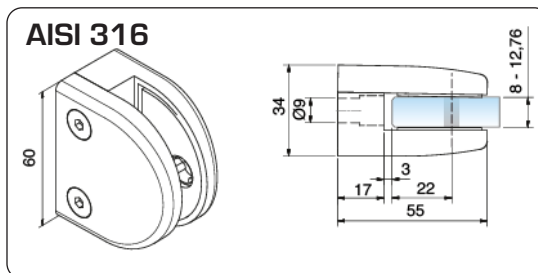
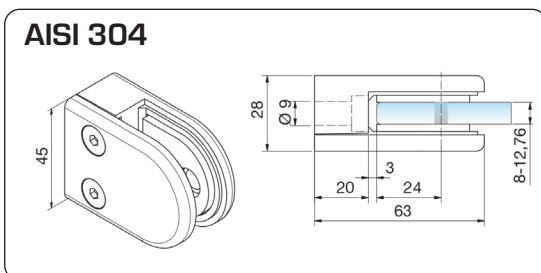

Klembeslag 4844/4845/4846/9045 zink, firkantet form med flad ende



Varenummer	for glas	overflade	ende	AISI	typenummer
120.484.4ZN.000	6-6,76 mm	rå zink	flad		-
120.484.4ZN.100	6-6,76 mm	matkrom	flad		
120.484.4ZN.500	6-6,76 mm	krom	flad		
120.484.4ZN.120	6-6,76 mm	grå	flad		
120.484.4ZN.140	6-6,76 mm	hvid	flad		
120.484.4ZN.160	6-6,76 mm	sort	flad		
120.484.4ZN.22K	6-6,76 mm	RS klarlak	flad		
120.484.5ZN.000	8-8,76 mm	rå zink	flad		
120.484.5ZN.100	8-8,76 mm	matkrom	flad		
120.484.5ZN.500	8-8,76 mm	krom	flad		
120.484.5ZN.120	8-8,76 mm	grå	flad		
120.484.5ZN.140	8-8,76 mm	hvid	flad		
120.484.5ZN.160	8-8,76 mm	sort	flad		
120.484.5ZN.22K	8-8,76 mm	RS klarlak	flad		
120.484.6ZN.000	10-10,76 mm	rå zink	flad		
120.484.6ZN.100	10-10,76 mm	matkrom	flad		
120.484.6ZN.500	10-10,76 mm	krom	flad		
120.484.6ZN.120	10-10,76 mm	grå	flad		
120.484.6ZN.140	10-10,76 mm	hvid	flad		
120.484.6ZN.160	10-10,76 mm	sort	flad		
120.484.6ZN.22K	10-10,76 mm	RS klarlak	flad		
120.484.6ZN.000	12-12,76 mm	rå zink	flad		
120.484.6ZN.100	12-12,76 mm	matkrom	flad		
120.484.6ZN.500	12-12,76 mm	krom	flad		
120.484.6ZN.120	12-12,76 mm	grå	flad		
120.484.6ZN.140	12-12,76 mm	hvid	flad		
120.484.6ZN.160	12-12,76 mm	sort	flad		
120.484.6ZN.22K	12-12,76 mm	RS klarlak	flad		

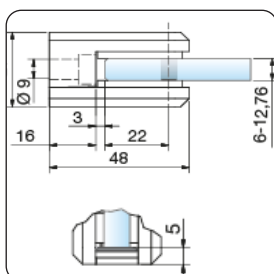
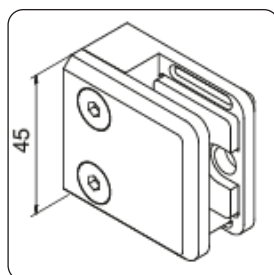

10

Klembeslag rustfrit stål firkantet flad ende VA2 [ANSI304]/VA4 [ANSI 316]



Varenummer	for glas	overflade	ende	AISI	typenummer
120.934.2VA.200	8-8,75 mm	rustfrit stål	flad	304	-
120.934.4VA.200	10-10,76 mm	rustfrit stål	flad	304	
120.934.0VA.200	12-12,76 mm	rustfrit stål	flad	304	
120.934.3VA.400	8-8,76 mm	rustfrit stål	flad	316	
120.934.4VA.400	10-10,76 mm	rustfrit stål	flad	316	
120.934.0VA.400	12-12,76 mm	rustfrit stål	flad	316	

Mål som ovenover

Klemmeslag 4861 for runde rør Ø42,4 mm

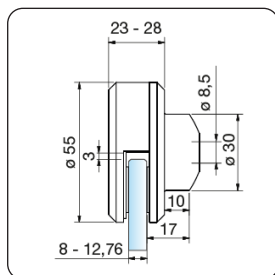

Varenummer	for glas	overflade ¹	-	typenummer
120.486.1ZN.000	8 - 12,76 mm	rå	-	-
120.486.1ZN.K22	8 - 12,76 mm	rustfrit look	-	-

¹⁾ Andre overflader på forespørgsel

Klemmeslag 4860 for firkantet rør

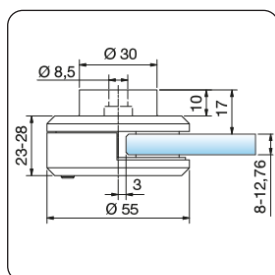

10

Varenummer	for glas	overflade ¹	-	typenummer
120.486.OZN.000	8 - 12,76 mm	rå	-	-
120.486.OZN.K22	8 - 12,76 mm	rustfrit look	-	-

¹⁾ Andre overflader på forespørgsel

Klemmeslag 4866 for firkantet rør

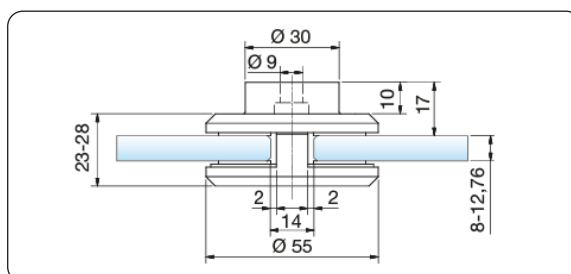

Varenummer	for glas	overflade ¹	-	typenummer
120.486.1ZN.000	8 - 12,76 mm	rå	-	-
120.486.1ZN.K22	8 - 12,76 mm	rustfrit look	-	-

¹⁾ Andre overflader på forespørgsel

Klemleslag 4891/4890/4893/9083 for tykkere glas

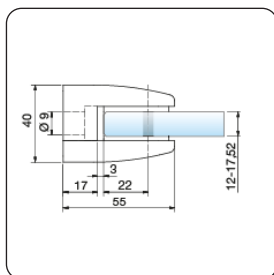

Varenummer	overflade ¹	for glas	typenummer
120.489.1ZN.000	rå	12 - 12,76 mm	-
120.489.0ZN.000	rå	13,52 mm	
120.489.3ZN.000	rå	16,76 mm	
120.908.3ZN.00	rå	17,52 mm	

¹⁾ Andre overflader på forespørgsel

Hjørneklembeslag 4830

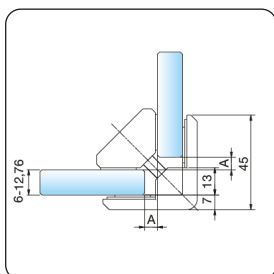

Varenummer	overflade ¹	højde	typenummer
120.483.0ZN.000	rå	45 mm	-
120.483.0ZN.K22	rustfrit look	45 mm	

¹⁾ Andre overflader på forespørgsel

Hjørneklembeslag 4875

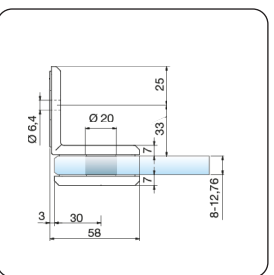

Varenummer	overflade ¹	højde	typenummer
120.483.0ZN.000	rå	45 mm	-
120.483.0ZN.K22	rustfrit look	45 mm	

¹⁾ Andre overflader på forespørgsel

Hjørneklembeslag 4874

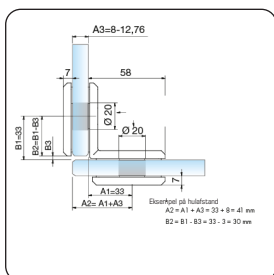

Varenummer	overflade ¹	højde	typenummer
120.487.4ZN.000	rå	45 mm	-
120.487.4ZN.K22	rustfrit look	45 mm	

¹⁾ Andre overflader på forespørgsel

10



Punktholdere

Produktoversigt 4

Pauli Punktholdere. 55

Pauli

Pauli + Sohn leverer et bredt sortiment af beslag og løsninger til montage af glas til ind- og udvendigt byggeri. Pauli har de senere år markeret sig kraftigt med designrigtige beslag til bygninger. Mange af beslagene er med Tysk Nationale tekniske godkendelse for byggeri.

Punktholder 1341 diameter $\varnothing 30$ mm

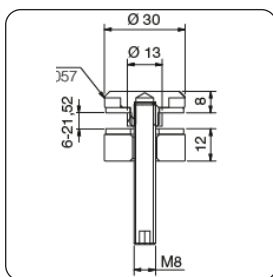

Varenummer	for glas	materiale	typenummer
120.134.100	6 - 21,52	AISI 304	-

Punktholder 7070

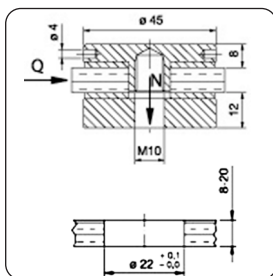

Varenummer	for glas	materiale	typenummer
120.707.0VA.000	6 - 21,52 mm	AISI 304	

Punktholder 7072

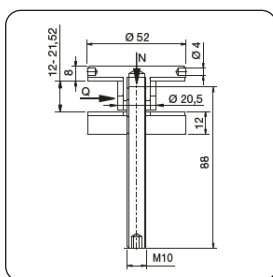

Varenummer	for glas	materiale	typenummer
120.707.204	12 - 21,52 mm	AISI 304	
120.707.216	12 - 21,52 mm	AISI 316	

Punktholder 7073

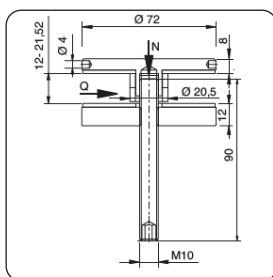

Varenummer	for glas	materiale	typenummer
120.707.304	12 - 21,52 mm	AISI 304	

10



25a

Glashalvtag

Produktoversigt 4

Glashalvtagsudhæng:

Baldakinprofil 58

Baldakin med stænger 60

Halvtagsprofiler:

JNC profiler 61

Pauli

Pauli + Sohn leverer et bredt sortiment af beslag og løsninger til montage af glas til ind- og udvendigt byggeri. Pauli har de senere år markeret sig kraftigt med designrigtige beslag til bygninger. Mange af beslagene er med Tysk Nationale tekniske godkendelse for byggeri.

Baldakinprofiler Type 1510-17 og 1511-17

- o Slankt, attraktivt design med minimal vedligeholdelse.
- o Natur eloxceret. Får i andre RAL farveer
- o Fås også til 21.52 mm glas.
- o Med hul for samlepind for montage af to profiler eller flere
- o Eksklusiv glas.

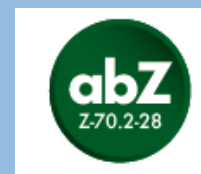

1510-17 Baldakinprofil med synlige huller for 17,52 mm glas



Varenummer	overflade	max. bredde x dybde	max. glasbred.	borehuller	typenummer
120.151.014.000	natur elox.	1400 x 1100 mm	1398 mm	7	-
120.151.016.000	natur elox.	1600 x 1100 mm	1598 mm	8	-
120.151.020.000	natur elox.	2000 x 1100 mm	1998 mm	10	-
120.151.024.000	natur elox.	2400 x 1100 mm	2398 mm	12	-

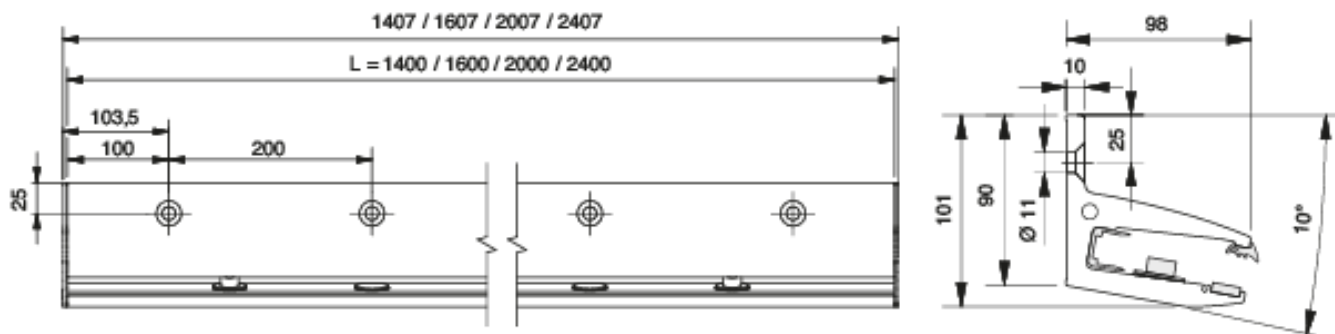

10

1511-17 Baldakinprofil med dækkappe for 17,52 mm glas

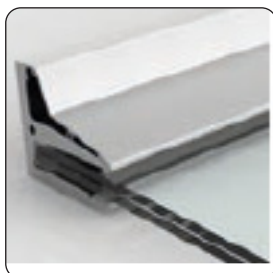

Varenummer	overflade	max bredde x dybde	max. glasbred.	borehuller	typenummer
120.151.114.000	natur elox.	1400 x 1100 mm	1398 mm	7	-
120.151.116.000	natur elox.	1600 x 1100 mm	1598 mm	8	-
120.151.118.000	natur elox.	1800 x 1100 mm	1798 mm	9	-
120.151.120.000	natur elox.	2000 x 1100 mm	1998 mm	10	-
120.151.124.000	natur elox.	2400 x 1100 mm	2398 mm	12	-

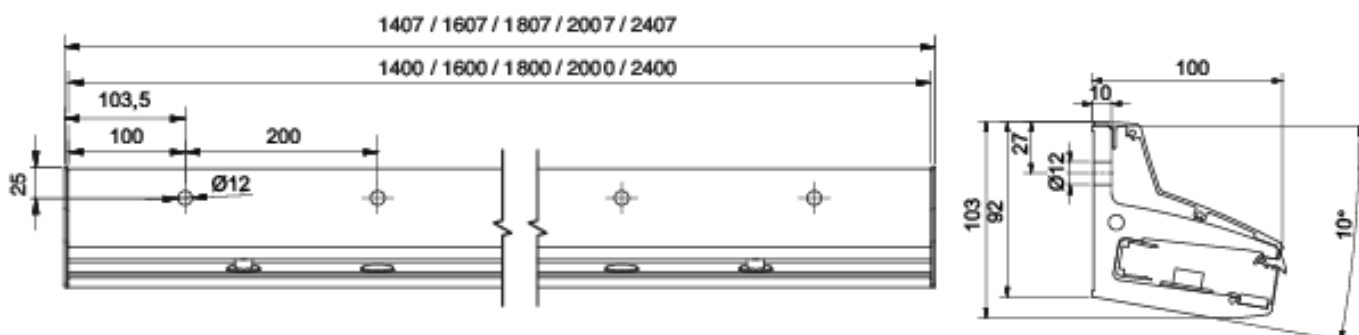



Baladakin med runde stænger.

- o Slankt, attraktivt design med minimal vedligeholdelse.
- o Glasstørrelse med 2 sæt max. 1400 x 1000 mm
- o Kan udvides med flere sæt.
- o Kræver hulboring
- o Ekskl. glas



Topbeslag for stang

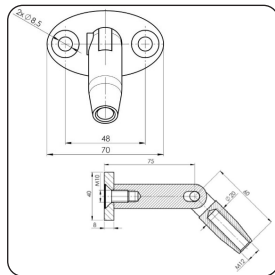

Varenummer	materiale	typenummer
136.A14.070.R00	rustfrit stål AISI 316	-

Punktholder for væg

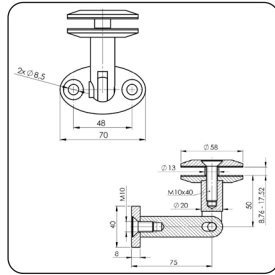

Varenummer	materiale	glastykkelse	typenummer
136.A14.070 .58R	rustfrit stål AISI 316	12,76-17,56	-

Punktholder for stang

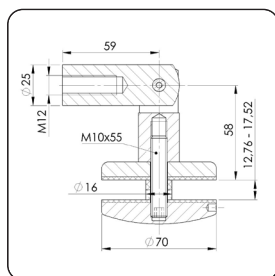

Varenummer	materiale	glastykkelse	typenummer
136.A14.070.000	rustfrit stål AISI 316	12,76-17,56	-

Stang

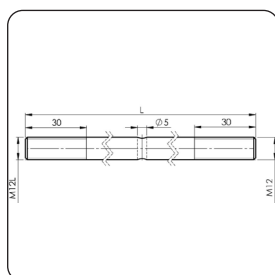

Varenummer	materiale	længde	typenummer
136.A14.100.0RO	rustfrit stål AISI 316	1000 mm	-
136.A14.125.0RO	rustfrit stål AISI 316	1250 mm	-
136.A14.150.0RO	rustfrit stål AISI 316	1500 mm	-
136.A14.200.0RO	rustfrit stål AISI 316	2000 mm	-

Baladakin med firkantet stænger.

- o Slankt, attraktivt design med minimal vedligeholdelse.
- o Kan fås til en større dybde, spørg Hansen Lellinge
- o Kan udvides med flere sæt
- o Kræver hulboring
- o Ekskl. glas



1778 Vægholder for stang

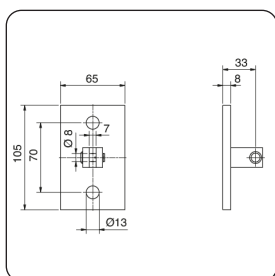

Varenummer	overflade	type	typenummer
120.177.800	rustfrit stål	AISI 304	-

1779 Vægholder for punktholder

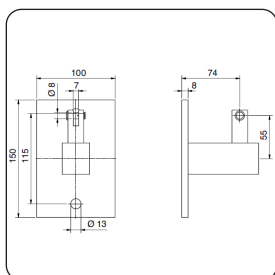

Varenummer	overflade	type	typenummer
120.177.900	rustfrit stål	AISI 304	-

1780 og 1781 Punktholder for henholdsvis stang og væg



Varenummer	overflade	type	typenummer
120.178.000	rustfrit stål	AISI 304	-
120.178.100	rustfrit stål	AISI 304	-

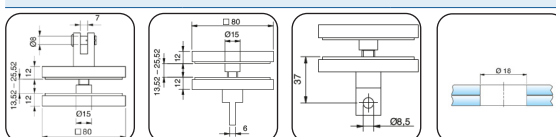

1777 Stang

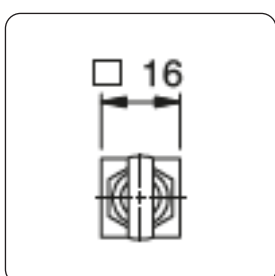

Varenummer	overflade	type	typenummer
120.177.700	rustfrit stål	AISI 304	-

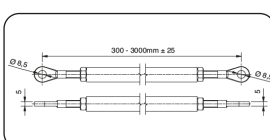

10

10

JNC glastagsprofil

Glastagsprofilerne fremstilles i aluminium og kan eksempelvis anvendes til halvtage, terrasseoverdækninger og glasudhæng. Topprofilen er som standard rå aluminium og ikke forboret og leveres i 6 meters længde. Afdækningsprofilen leveres i naturelokseret eller hvid (RAL 9010) overflade. Profilerne anvendes med enkeltlags-, lamineret-, eller termoglas. Alle glastykkelser kan anvendes, da højden er afhængig af skrueens længde.

Hvis glastagsprofilen monteres på spær smallere end 50 mm, anbefales det at bruge to topprofiler, hvor det ene fungerer som bundprofil.

Gummibundprofilen anvendes i forbindelse med montering direkte på lægter.

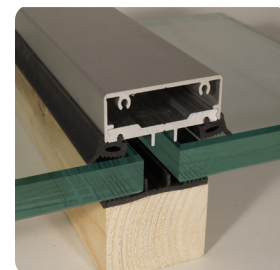

Topprofil inkl. sort gummitætning, rå aluminium, anvendes også som bundprofil

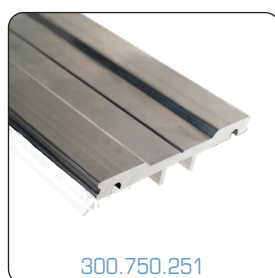

Varenummer	gummi	lgd.	bredde	typenummer
300.750.250	6 mm	6 m	56 mm	75.0250
300.750.251	3 mm	6 m	56 mm	75.0251

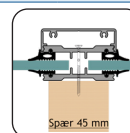
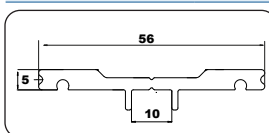

Gummibundprofil til spær

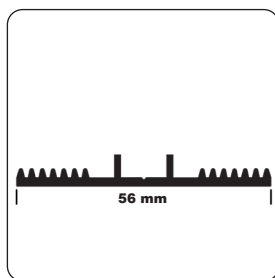

Varenummer	farve	lgd.	bredde	typenummer
300.750.275	sort	6 m	56 mm	75.0270

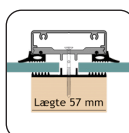

Afdækningsprofil til topprofil

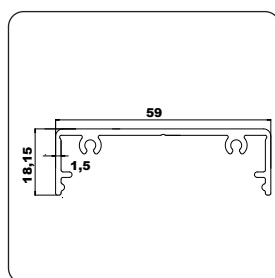

Varenummer	overflade	lgd.	bredde	typenummer
300.750.263	naturelokseret	6 m	59 mm	75.0260
300.750.267	hvid RAL9010	6 m	59 mm	75.0260H

Endekappe forboret

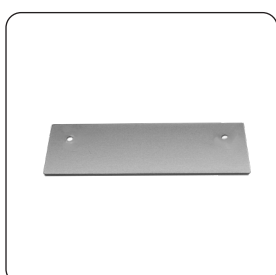

Varenummer	overflade	H x B	typenummer
300.750.283	naturelokseret	23 x 56 mm	75.0280
300.750.287	hvid	23 x 56 mm	75.0280H
300.750.293	naturelokseret	20 x 56 mm	75.0281
300.750.297	hvid	20 x 56 mm	75.0281H



Se vort katalog nr. 5 PROFILER hvis du søger standard eller specielle profiler. Her er alt hvad vi har på lager af eloxerede, farvet og børstet aluminiumsprofiler samt messing og rustfrit stål profiler.



Hansen Lellinge A/S leverer løsninger til glaskonstruktioner og dørteknik fra anerkendte kvalitetsleverandører af profilsystemer, beslag, låse, dørautomatik og glarmesterprodukter.

Vi yder kompetent teknisk og praktisk rådgivning, og deltager gerne i projekter fra idéfase til færdiggørelse.

Vores udstilling og vore faguddannede medarbejdere står til rådighed, og vi henviser gerne til relevante håndværkere.

Vi lagerfører et omfattende sortiment af produkter og tilbehør, for hurtig levering og har eget værksted for tilpasning og specialløsninger.

Velkommen hos Hansen Lellinge A/S og på www.hansenlellinge.dk

Hansen Lellinge A/S
 Mårkærvej 7
 2630 Taastrup
www.hansenlellinge.dk
info@hansenlellinge.dk
 Kundeservice: 43 71 16 40

HANSEN  LELLINGE

