

Diamantek	s.	7
Dorma Glas	s.	29
Normbau	s.	33
Randi	s.	38
d line	s.	42
Andre	s.	45

## 9. DØRHANKE

Hansen Lellinge A/S er leverandør for alt inden for glasmontage. Vi kan hjælpe med rådgive og finde de rette beslag til din glasdørsløsning, alt efter dine ønsker og behov.

I dette katalog præsenterer vi de standard dørhanke som er mest anvendte, mange af disse dørhanke bliver også lagerført på vores lager i Taastrup.





# Indholdsfortegnelse

---

## *Diamatek:*

<i>Messing</i> . . . . .	6
<i>Træ/Messing</i> . . . . .	12
<i>Rustfrit stål</i> . . . . .	13
<i>Træ/Rustfrit stål</i> . . . . .	24
<i>Træ</i> . . . . .	26

## *Dorma Glas:*

<i>Rustfrit stål</i> . . . . .	30
--------------------------------	----

## *Normbau:*

<i>Rustfrit stål</i> . . . . .	34
--------------------------------	----

## *Randi:*

<i>Rustfrit stål</i> . . . . .	39
--------------------------------	----

## *d line:*

<i>Rustfrit stål</i> . . . . .	43
--------------------------------	----

## *Stremler:*

<i>Rustfrit stål</i> . . . . .	45
--------------------------------	----

## *CBM:*

<i>Rustfrit stål</i> . . . . .	46
--------------------------------	----

## *Assa Abloy:*

<i>Rustfrit stål</i> . . . . .	47
--------------------------------	----

## *pba:*

<i>Rustfrit stål</i> . . . . .	47
--------------------------------	----

## Messing



	Diamantek	Diamantek	Diamantek	Diamantek	Diamantek
	K2	K4	S0	SC-T	KR
	U-hank	Forkrøppet U-hank	T-hank	T-hank m. vinkelben	Cirkelhanke
Montage	Glas	Glas	Glas	Glas	Glas
Antal ben	2	2	2	2	2
Diameter	19/20/25/30/32/38	19/20/25/30/32/38	19/20/25/30/32/38	Ø32 / Ø38 mm	Ø25 / Ø32 mm
CC	250 - 2.200 mm	250 - 2.200 mm	250 - 1.800 mm	400 - 2.200 mm	250 - 400 mm
Overflade	Poleret	Poleret	Poleret	Poleret	Poleret
Produktdata	s. 8	s. 9	s. 10	s.11	s.12

## Rustfrit stål



	Normbau	Diamantek	Diamantek	Diamantek	Diamantek	Diamantek
	Type 122	SQ	SQ3	SQ4	SLK	SLK3
	T-hank	Firkantet T-hank	Firkantet T-hank	Firkantet T-hank	T-hank	T-hank
Montage	Glas/træ/alu	Glas	Glas	Glas	Glas	Glas
Antal ben	2	2	3	4	2	3
Diameter	Ø20/Ø26/Ø32 mm	30 x 30 mm	30 x 30 mm	30 x 30 mm	Ø32 / Ø38 mm	Ø32 / Ø38 mm
CC	150 - 1.400 mm	400 - 1.600 mm	1.000 - 2.200 mm	1.600 - 2.400 mm	600 - 2.200 mm	1.000 - 2.400 mm
Overflade	matbørstet	matbørstet	matbørstet	matbørstet	matbørstet	matbørstet
Produktdata	s. 35	s. 17	s. 17	s. 17	s. 20	s. 20



	Randi	d line	Diamantek	Normbau	Randi	dline
	1512/1513/1514	-	K4	Type 23	1532/1533/1534	-
	U-hank	U-hank	Forkrøppet U-hank	Forkrøppet U-hank	Forkrøppet U-hank	Forkrøppet U-hank
Montage	Glas/træ/alu	Glas/træ/alu	Glas	Glas/træ/alu	Glas/træ/alu	Glas/træ/alu
Antal ben	2	2	2	2	2	2
Diameter	Ø14/16/19 mm	Ø14/19/25/32 mm	Ø19/20/25/30 mm	Ø20/26/32/40 mm	Ø14/16/19 mm	Ø14/19/25/32 mm
CC	125 - 650 mm	125 - 650 mm	250 - 1.800 mm	200 - 400 mm	125 - 650 mm	125 - 650 mm
Overflade	matbørstet	matbørstet	matbørstet	matbørstet	matbørstet	matbørstet
Produktdata	s. 39	s. 43	s. 14	s. 36	s. 39	s. 43

**Rustfrit stål**



	Diamantek	Diamantek	Diamantek	Dorma Glas	Dorma Glas	Dorma Glas
	S0 T-hank	S3 T-hank	S4 T-hank	Manet T-hank - enkelt	Manet T-hank	med lås T-hank
Montage	Glas	Glas	Glas	Glas	Glas	Glas
Antal ben	2	3	4	2	2	2
Diameter	19/20/25/30/32/38	Ø20/Ø30/Ø38 mm	Ø25/Ø30/Ø38 mm	Ø25 mm	Ø25 mm	Ø25 mm
CC	250 - 2.200 mm	1.000 - 2.400 mm	1.400 - 2.400 mm	150 - 520 mm	150 - 520 mm	150 - 520 mm
Overflade	matbørstet	matbørstet	matbørstet	matbørstet	matbørstet	matbørstet
Produktdata	s. 18	s. 19	s. 19	s. 30	s. 30	s. 32



	Diamantek	Diamantek	Diamantek	Diamantek	Diamantek	Dorma Glas	Normbau
	SLK4 T-hank	SC T-hank m. vinkelben	SC3 T-hank m. vinkelben	SC4 T-hank m. vinkelben	K2 U-hank	Arcos U-hank	Type 22 U-hank
	Glas	Glas	Glas	Glas	Glas	Glas	Glas/træ/alu
	4	2	3	4	2	2	2
	Ø32 / Ø38 mm	Ø32 / Ø38 mm	Ø32 / Ø38 mm	Ø32 / Ø38 mm	19/20/25/30/32/38	Ø25 mm	Ø20 / Ø32 mm
	1.600 - 2.400 mm	400 - 2.200 mm	1.000 - 2.400 mm	1.600 - 2.400 mm	250 - 2.200 mm	150 - 520 mm	120 - 500 mm
	matbørstet	matbørstet	matbørstet	matbørstet	matbørstet	matbørstet	matbørstet
	s. 21	s. 22	s. 22	s. 23	s. 13	s. 31	s. 34



	Dorma Glas	Normbau	Diamantek	Diamantek	Normbau	Diamantek	Normbau
	Beyond Geringshank	Type 222 Geringshank	K2K Geringshank	K4K Geringshank	Type 24 Forkrøppet hank	KR Cirkelhank	Type 25 Cirkelhank
	Glas	Glas/træ/alu	Glas	Glas	Glas/træ/alu	Glas	Glas / træ / alu
	2	2	2	2	2	2	2
	Ø22 mm	Ø20 mm	Ø20/25/30/32 mm	Ø19/20/30/32/38	Ø26 / Ø32 mm	Ø26 / Ø32 mm	Ø26 / Ø32 mm
	150 - 520 mm	200 - 400 mm	250 - 2.200 mm	250 - 2.200 mm	300 - 400 mm	250 - 400 mm	200 - 400 mm
	matbørstet	matbørstet	matbørstet	matbørstet	matbørstet	matbørstet	matbørstet
	s. 31	s. 35	s. 15	s. 16	s. 36	s. 23	s. 36

## Træ/stål



	Diamantek	Diamantek	Diamantek	Diamantek
	PO	PO	P3	P4
	T-hank	T-hank	T-hank	T-hank
Montage	Glas	Glas	Glas	Glas
Antal ben	2	2	3	4
Diameter	Ø32 / Ø38 mm	Ø32 / Ø38 mm	Ø32 / Ø38 mm	Ø32 / Ø38 mm
CC	300 - 1.000 mm	300 - 1.000 mm	1.000 - 2.000 mm	1.600 - 2.400 mm
Overflade	Egetræ og messing	Egetræ og rustfrit	Egetræ og rustfrit	Egetræ og rustfrit
Produktdata	s. 12	s. 24	s. 24	s. 24

## Træ/stål



	Diamantek	Diamantek	Diamantek
	PP	PP3	PP4
	T-hank	T-hank	T-hank
Montage	Glas	Glas	Glas
Antal ben	2	3	4
Diameter	Ø25 / Ø32 mm	Ø32 / Ø38 mm	Ø32/Ø38
CC	300 - 1.000 mm	1.000 - 2.000 mm	1800/2600 mm
Overflade	Egetræ	Egetræ	Egetræ
Produktdata	s. 26	s. 26	s.26

## Træ/stål



	Diamantek	Diamantek
	PRLS	PQLS
	T-hank	Firkantet T-hank
Montage	Glas	Glas
Antal ben	2	2
Diameter	Ø50	50 x 50 mm
CC	2.000 - 2.400 mm	2.000 - 2.400 mm
Overflade	Egetræ og rust	Egetræ og rust
Produktdata	s. 27	s. 27



## Dørhanke • Diamantek

*Produktoversigt* . . . . . 4

*Messing:*

*U-hanke* . . . . . 8  
*Forkrøppet u-hanke* . . . . . 9  
*T-hanke* . . . . . 10  
*Cirkelhanke* . . . . . 12

*Træ/Messing:*

*T-hanke* . . . . . 12

*Rustfrit stål:*

*U-hanke* . . . . . 13  
*Forkrøppet u-hanke* . . . . . 14  
*Geringshanke* . . . . . 15  
*Forkrøppet geringshanke* . . . . . 16  
*T-hanke* . . . . . 17  
*Cirkelhanke* . . . . . 23

*Træ/Rustfrit stål:*

*T-hanke* . . . . . 24

*Træ:*

*T-hanke* . . . . . 26

**Diamantek**

Diamanteks dørhanke er lavet af et godt håndværk med fokus på detaljerne og præcision. Siden år 2000 har de udvidet deres sortiment af dørhanke i forskellige udformninger, stilarter og materialer.

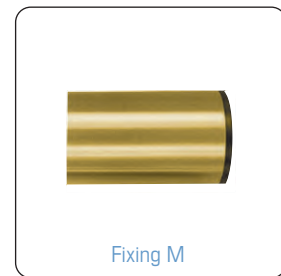

## Classic K2 U-hank messing

poleret rå messing, sæt

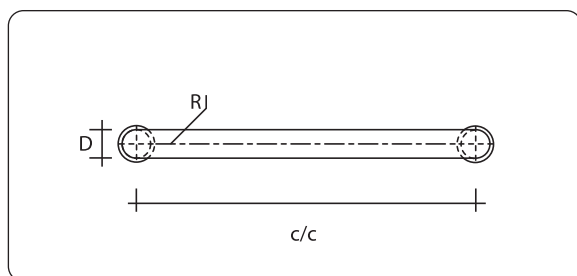
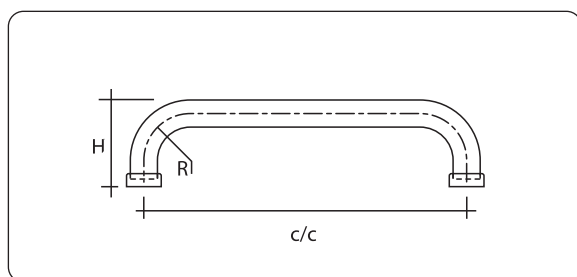

8

Varenummer <sup>1)</sup>	D	R	H	C/C
126.MU19.0250	Ø19	25	61	250
126.MU19.0300	Ø19	25	61	300
126.MU19.0400	Ø19	25	61	400
126.MU19.0600	Ø19	25	61	600
126.MU20.0250	Ø20	38	67	250
126.MU20.0300	Ø20	38	67	300
126.MU20.0400	Ø20	38	67	400
126.MU20.0600	Ø20	38	67	600
126.MU20.0800	Ø20	38	67	800
126.MU25.0250	Ø25	43	72	250
126.MU25.0300	Ø25	43	72	300
126.MU25.0400	Ø25	43	72	400
126.MU25.0600	Ø25	43	72	600
126.MU25.0800	Ø25	43	72	800
126.MU25.1000	Ø25	43	72	1.000
126.MU25.1200	Ø25	43	72	1.200
126.MU30.0400	Ø30	50	82	400
126.MU30.0600	Ø30	50	82	600
126.MU30.0800	Ø30	50	82	800
126.MU30.1000	Ø30	50	82	1.000
126.MU30.1200	Ø30	50	82	1.200
126.MU30.1400	Ø30	50	82	1.400
126.MU30.1600	Ø30	50	82	1.600
126.MU32.0400	Ø32	56	84	400
126.MU32.0600	Ø32	56	84	600
126.MU32.0800	Ø32	56	84	800
126.MU32.1000	Ø32	56	84	1.000
126.MU32.1200	Ø32	56	84	1.200
126.MU32.1400	Ø32	56	84	1.400
126.MU32.1600	Ø32	56	84	1.600
126.MU38.0400	Ø38	70	110	400
126.MU38.0600	Ø38	70	110	600
126.MU38.0800	Ø38	70	110	800
126.MU38.1000	Ø38	70	110	1.000
126.MU38.1200	Ø38	70	110	1.200
126.MU38.1400	Ø38	70	110	1.400
126.MU38.1600	Ø38	70	110	1.600
126.MU38.1800	Ø38	70	110	1.800
126.MU38.2000	Ø38	70	110	2.000
126.MU38.2200	Ø38	70	110	2.200

<sup>1)</sup> Inkl. montagesæt for glas

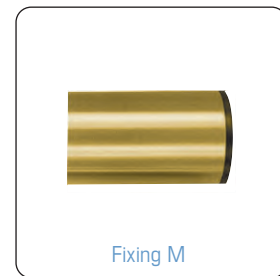

## Classic K4 forkrøppet U-hank messing poleret rå messing, sæt

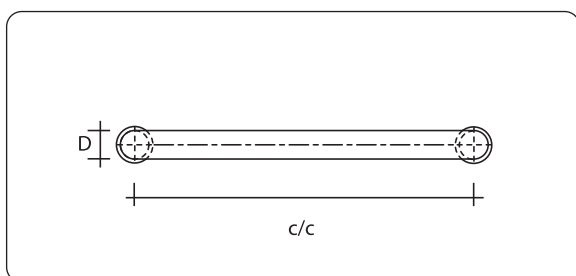
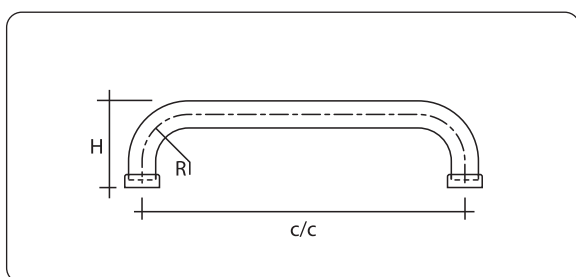

Varenummer <sup>1</sup>	D	R	H	C/C
126.MF19.0250	Ø19	25	61	250
126.MF19.0300	Ø19	25	61	300
126.MF19.0400	Ø19	25	61	400
126.MF19.0600	Ø19	25	61	600
126.MF20.0250	Ø20	38	67	250
126.MF20.0300	Ø20	38	67	300
126.MF20.0400	Ø20	38	67	400
126.MF20.0600	Ø20	38	67	600
126.MF20.0800	Ø20	38	67	800
126.MF25.0250	Ø25	43	72	250
126.MF25.0300	Ø25	43	72	300
126.MF25.0400	Ø25	43	72	400
126.MF25.0600	Ø25	43	72	600
126.MF25.0800	Ø25	43	72	800
126.MF25.1000	Ø25	43	72	1.000
126.MF25.1200	Ø25	43	72	1.200
126.MF30.0400	Ø30	50	82	400
126.MF30.0600	Ø30	50	82	600
126.MF30.0800	Ø30	50	82	800
126.MF30.1000	Ø30	50	82	1.000
126.MF30.1200	Ø30	50	82	1.200
126.MF30.1400	Ø30	50	82	1.400
126.MF30.1600	Ø30	50	82	1.600
126.MF32.0400	Ø32	56	84	400
126.MF32.0600	Ø32	56	84	600
126.MF32.0800	Ø32	56	84	800
126.MF32.1000	Ø32	56	84	1.000
126.MF32.1200	Ø32	56	84	1.200
126.MF32.1400	Ø32	56	84	1.400
126.MF32.1600	Ø32	56	84	1.600
126.MF38.0600	Ø38	70	110	600
126.MF38.0800	Ø38	70	110	800
126.MF38.1000	Ø38	70	110	1.000
126.MF38.1200	Ø38	70	110	1.200
126.MF38.1400	Ø38	70	110	1.400
126.MF38.1600	Ø38	70	110	1.600
126.MF38.1800	Ø38	70	110	1.800

<sup>1)</sup> Inkl. montagesæt for glas



## Metropol SO T-hank

poleret rå messing, sæt

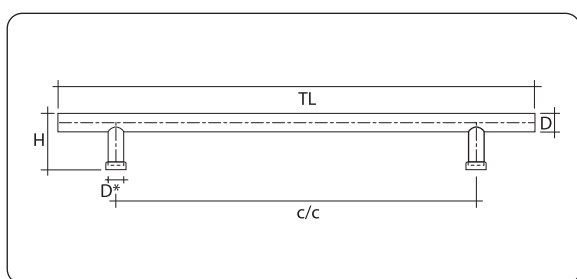

8



Varenummer <sup>1)</sup>	D	R	B	H	C/C
126.MT19.0250.0350	Ø19	25	100	71	250
126.MT19.0300.0400	Ø19	25	100	71	300
126.MT19.0400.0600	Ø19	25	100	71	400
126.MT19.0600.0800	Ø19	25	100	71	600
126.MT20.0250.0350	Ø20	38	92	72	250
126.MT20.0300.0400	Ø20	38	92	72	300
126.MT20.0400.0600	Ø20	38	92	72	400
126.MT20.0600.0800	Ø20	38	92	72	600
126.MT20.0800.1000	Ø20	38	92	72	800
126.MT25.0300.0400	Ø25	43	86	77	300
126.MT25.0400.0600	Ø25	43	86	77	400
126.MT25.0600.0800	Ø25	43	86	77	600
126.MT25.0800.1000	Ø25	43	86	77	800
126.MT25.1000.1200	Ø25	43	86	77	1.000
126.MT25.1200.1400	Ø25	43	86	77	1.200
126.MT28.0300.0400	Ø30	50	100	82	300
126.MT28.0400.0600	Ø30	50	100	82	400
126.MT28.0600.0800	Ø30	50	100	82	600
126.MT28.0800.1000	Ø30	50	100	82	800
126.MT28.1000.1200	Ø30	50	100	82	1.000
126.MT28.1200.1400	Ø30	50	100	82	1.200
126.MT30.0300.0400	Ø32	56	112	84	300
126.MT30.0400.0600	Ø32	56	112	84	400
126.MT30.0600.0800	Ø32	56	112	84	600
126.MT30.0800.1000	Ø32	56	112	84	800
126.MT30.1000.1200	Ø32	56	112	84	1.000
126.MT30.1200.1400	Ø32	56	112	84	1.200
126.MT30.1400.1600	Ø32	56	112	84	1.400
126.MT30.1600.1800	Ø32	56	112	84	1.600
126.MT32.0400.0600	Ø38	70	140	90	400
126.MT32.0600.0800	Ø38	70	140	90	600
126.MT32.0800.1000	Ø38	70	140	90	800
126.MT32.1000.1200	Ø38	70	140	90	1.000
126.MT32.1200.1400	Ø38	70	140	90	1.200
126.MT32.1400.1600	Ø38	70	140	90	1.400
126.MT32.1600.1800	Ø38	70	140	90	1.600
126.MT38.1800.1400	Ø38	70	140	90	1.800
126.MT38.2000.1600	Ø38	70	140	90	2.000
126.MT38.2200.1800	Ø38	70	140	90	2.200

<sup>1)</sup> Inkl. montagesæt for glas

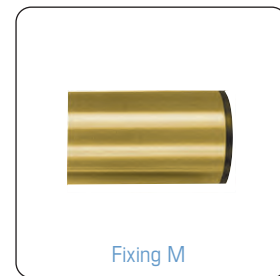

## Stylish SC T-hank med vinkelben

poleret rå messing, sæt

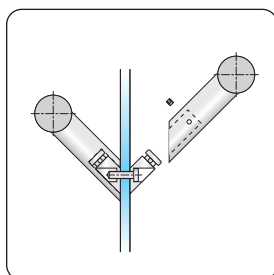
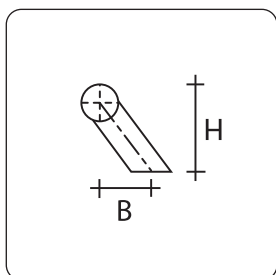
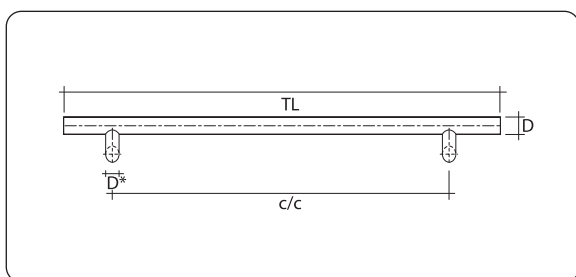

Varenummer <sup>1</sup>	D	D*	B	H	TL	C/C
126.MV32.0400.0600	Ø32	Ø25	60	84	600	400
126.MV32.0600.0800	Ø32	Ø25	60	84	800	600
126.MV32.0800.1000	Ø32	Ø25	60	84	1.000	800
126.MV32.1000.1200	Ø32	Ø25	60	84	1.200	1.000
126.MV32.1200.1400	Ø32	Ø25	60	84	1.400	1.200
126.MV32.1400.1600	Ø32	Ø25	60	84	1.600	1.400
126.MV32.1600.1800	Ø32	Ø25	60	84	1.800	1.600
126.MV38.0600.0600	Ø38	Ø30	63	90	800	600
126.MV38.0800.0800	Ø38	Ø30	63	90	1.000	800
126.MV38.1000.1000	Ø38	Ø30	63	90	1.200	1.000
126.MV38.1200.1200	Ø38	Ø30	63	90	1.400	1.200
126.MV38.1400.1400	Ø38	Ø30	63	90	1.600	1.400
126.MV38.1600.1600	Ø38	Ø30	63	90	1.800	1.600
126.MV38.1800.1400	Ø38	Ø30	63	90	2.000	1.800
126.MV38.2000.1600	Ø38	Ø30	63	90	2.200	2.000
126.MV38.2200.1800	Ø38	Ø30	63	90	2.400	2.200

<sup>1)</sup> Inkl. montagesæt for glas

## Classic KR cirkelhanke poleret rå messing, sæt

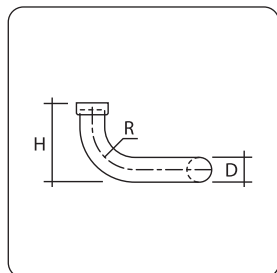
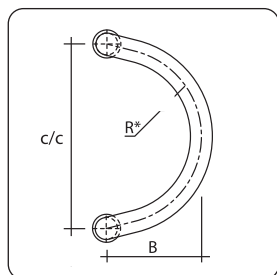

Varenummer <sup>1</sup>	D	R	H	B	C/C
126.MC25.0250	25	43	72	110	250
126.MC25.0300	25	43	72	210	300
126.MC25.0320	25	43	72	200	320
126.MC32.0300	32	56	84	205	300
126.MC32.0350	32	56	84	230	350
126.MC32.0380	32	56	84	240	380
126.MC32.0400	32	56	84	255	400

<sup>1)</sup> Inkl. montagesæt for glas

8

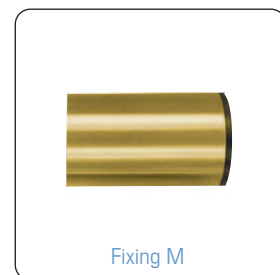

## Metropol oak PO T-hanke egetræ og poleret rå messing, sæt

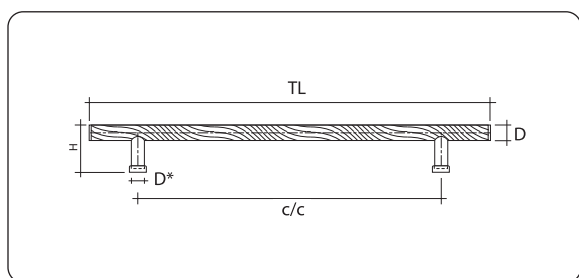

Varenummer <sup>1</sup>	D	D	H	TL	C/C
126.TMT.32.0300.0400	Ø32	Ø25	84	400	300
126.TMT.32.0400.0600	Ø32	Ø25	84	600	400
126.TMT.32.0600.0800	Ø32	Ø25	84	800	600
126.TMT.38.0400.0600	Ø38	Ø30	90	600	400
126.TMT.38.0600.0800	Ø38	Ø30	90	800	600
126.TMT.38.0800.1000	Ø38	Ø30	90	1.000	800
126.TMT.38.1000.1200	Ø38	Ø30	90	1.200	1.000

<sup>1)</sup> Inkl. montagesæt for glas

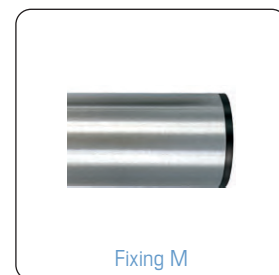

## Classic K2 U-hank

børstet rustfrit stål AISI 304, sæt

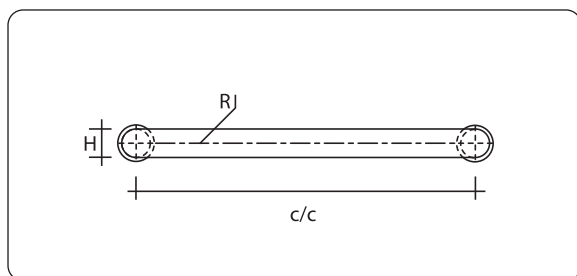
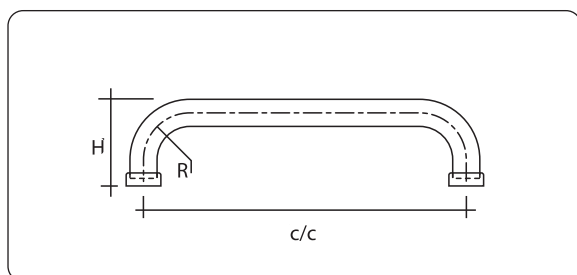

Varenummer <sup>1</sup>	D	R	H	C/C
126.U19.0250	Ø19	25	61	250
126.U19.0300	Ø19	25	61	300
126.U19.0400	Ø19	25	61	400
126.U19.0600	Ø19	25	61	600
126.U20.0250	Ø20	38	67	250
126.U20.0300	Ø20	38	67	300
126.U20.0400	Ø20	38	67	400
126.U20.0600	Ø20	38	67	600
126.U20.0800	Ø20	38	67	800
126.U25.0250	Ø25	43	72	250
126.U25.0300	Ø25	43	72	300
126.U25.0400	Ø25	43	72	400
126.U25.0600	Ø25	43	72	600
126.U25.0800	Ø25	43	72	800
126.U25.1000	Ø25	43	72	1.000
126.U25.1200	Ø25	43	72	1.200
126.U30.0400	Ø30	50	82	400
126.U30.0600	Ø30	50	82	600
126.U30.0800	Ø30	50	82	800
126.U30.1000	Ø30	50	82	1.000
126.U30.1200	Ø30	50	82	1.200
126.U30.1400	Ø30	50	82	1.400
126.U30.1600	Ø30	50	82	1.600
126.U32.0400	Ø32	56	84	400
126.U32.0600	Ø32	56	84	600
126.U32.0800	Ø32	56	84	800
126.U32.1000	Ø32	56	84	1.000
126.U32.1200	Ø32	56	84	1.200
126.U32.1400	Ø32	56	84	1.400
126.U32.1600	Ø32	56	84	1.600
126.U38.0400	Ø38	70	110	400
126.U38.0600	Ø38	70	110	600
126.U38.0800	Ø38	70	110	800
126.U38.1000	Ø38	70	110	1.000
126.U38.1200	Ø38	70	110	1.200
126.U38.1400	Ø38	70	110	1.400
126.U38.1600	Ø38	70	110	1.600
126.U38.1800	Ø38	70	110	1.800
126.U38.2000	Ø38	70	110	2.000
126.U38.2200	Ø38	70	110	2.200

<sup>1)</sup> Inkl. montagesæt for glas

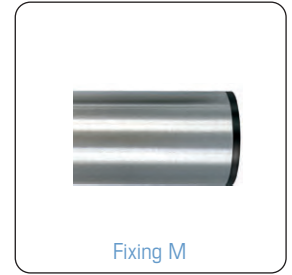

## Classic K4 forkrøppet U-hank

børstet rustfrit stål AISI 304, sæt

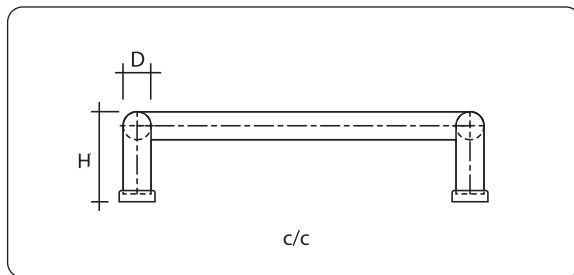
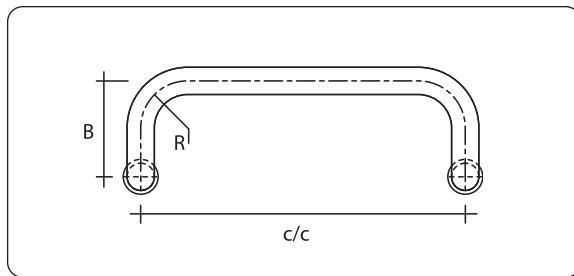

Varenummer <sup>1</sup>	D	R	B	H	C/C
126.F19.0250	Ø19	25	100	69	250
126.F19.0300	Ø19	25	100	69	300
126.F19.0400	Ø19	25	100	69	400
126.F19.0600	Ø19	25	100	69	600
126.F20.0250	Ø20	38	92	75	250
126.F20.0300	Ø20	38	92	75	300
126.F20.0400	Ø20	38	92	75	400
126.F20.0600	Ø20	38	92	75	600
126.F20.0800	Ø20	38	92	75	800
126.F25.0250	Ø25	43	86	80	250
126.F25.0300	Ø25	43	86	80	300
126.F25.0400	Ø25	43	86	80	400
126.F25.0600	Ø25	43	86	80	600
126.F25.0800	Ø25	43	86	80	800
126.F25.1000	Ø25	43	86	80	1.000
126.F25.1200	Ø25	43	86	80	1.200
126.F30.0400	Ø30	50	100	90	400
126.F30.0600	Ø30	50	100	90	600
126.F30.0800	Ø30	50	100	90	800
126.F30.1000	Ø30	50	100	90	1.000
126.F30.1200	Ø30	50	100	90	1.200
126.F30.1400	Ø30	50	100	90	1.400
126.F30.1600	Ø30	50	100	90	1.600
126.F32.0400	Ø32	56	112	92	400
126.F32.0600	Ø32	56	112	92	600
126.F32.0800	Ø32	56	112	92	800
126.F32.1000	Ø32	56	112	92	1.000
126.F32.1200	Ø32	56	112	92	1.200
126.F32.1400	Ø32	56	112	92	1.400
126.F32.1600	Ø32	56	112	92	1.600
126.F38.0600	Ø38	70	140	108	600
126.F38.0800	Ø38	70	140	108	800
126.F38.1000	Ø38	70	140	108	1.000
126.F38.1200	Ø38	70	140	108	1.200
126.F38.1400	Ø38	70	140	108	1.400
126.F38.1600	Ø38	70	140	108	1.600
126.F38.1800	Ø38	70	140	108	1.800

<sup>1)</sup> Inkl. montagesæt for glas

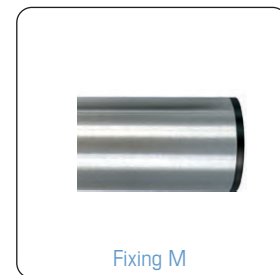

## Elegance K2K geringshanke

børstet rustfrit stål AISI 304, sæt

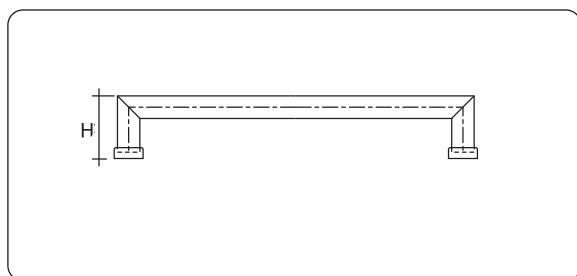
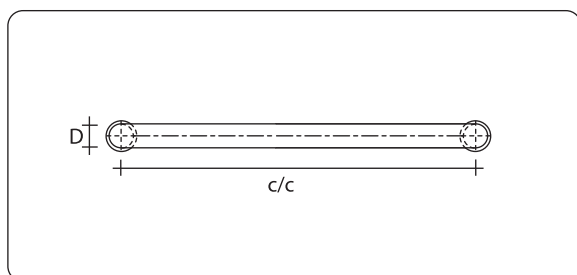

Varenummer	D	H	C/C
126.G20.0250	Ø20	62	250
126.G20.0300	Ø20	62	300
126.G20.0400	Ø20	62	400
126.G20.0600	Ø20	62	600
126.G20.0800	Ø20	62	800
126.G25.0250	Ø25	67	250
126.G25.0300	Ø25	67	300
126.G25.0400	Ø25	67	400
126.G25.0600	Ø25	67	600
126.G25.0800	Ø25	67	800
126.G25.1000	Ø25	67	1.000
126.G25.1200	Ø25	67	1.200
126.G30.0400	Ø30	72	400
126.G30.0600	Ø30	72	600
126.G30.0800	Ø30	72	800
126.G30.1000	Ø30	72	1.000
126.G30.1200	Ø30	72	1.200
126.G30.1400	Ø30	72	1.400
126.G30.1600	Ø30	72	1.600
126.G30.1800	Ø30	72	1.800
126.G30.2000	Ø30	72	2.000
126.G32.0400	Ø32	74	400
126.G32.0600	Ø32	74	600
126.G32.0800	Ø32	74	800
126.G32.1000	Ø32	74	1.000
126.G32.1200	Ø32	74	1.200
126.G32.1400	Ø32	74	1.400
126.G32.1600	Ø32	74	1.600
126.G32.1800	Ø32	74	1.800
126.G32.2000	Ø32	74	2.000
126.G38.6400	Ø38	80	600
126.G38.0800	Ø38	80	800
126.G38.1000	Ø38	80	1.000
126.G38.1200	Ø38	80	1.200
126.G38.1400	Ø38	80	1.400
126.G38.1600	Ø38	80	1.600
126.G38.1800	Ø38	80	1.800
126.G38.2000	Ø38	80	2.000
126.G38.2000	Ø38	80	2.200

<sup>1)</sup> Inkl. montagesæt for glas



**Elegance K4K forkrøppet geringshanke** børstet rustfrit stål AISI 304, sæt

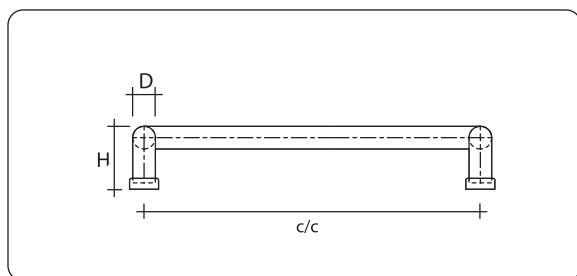
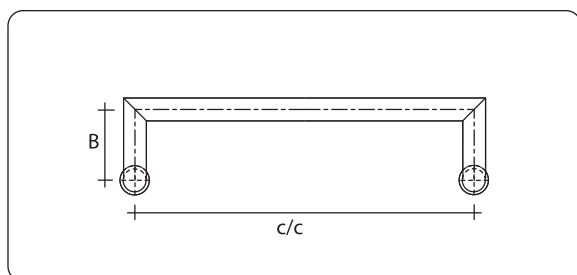

8

Varenummer	D	B	H	C/C
126.K19.0250	Ø19	86	61	250
126.K19.0300	Ø19	86	61	300
126.K19.0400	Ø19	86	61	400
126.K19.0600	Ø19	86	61	600
126.K20.0250	Ø20	86	62	250
126.K20.0300	Ø20	86	62	300
126.K20.0400	Ø20	86	62	400
126.K20.0600	Ø20	86	62	600
126.K20.0800	Ø20	86	62	800
126.K25.0250	Ø25	86	67	250
126.K25.0300	Ø25	86	67	300
126.K25.0400	Ø25	86	67	400
126.K25.0600	Ø25	86	67	600
126.K25.0800	Ø25	86	67	800
126.K25.1000	Ø25	86	67	1.000
126.K25.1200	Ø25	86	67	1.200
126.K30.0400	Ø30	100	72	400
126.K30.0600	Ø30	100	72	600
126.K30.0800	Ø30	100	72	800
126.K30.1000	Ø30	100	72	1.000
126.K30.1200	Ø30	100	72	1.200
126.K30.1400	Ø30	100	72	1.400
126.K30.1600	Ø30	100	72	1.600
126.K32.0400	Ø32	112	74	400
126.K32.0600	Ø32	112	74	600
126.K32.0800	Ø32	112	74	800
126.K32.1000	Ø32	112	74	1.000
126.K32.1200	Ø32	112	74	1.200
126.K32.1400	Ø32	112	74	1.400
126.K32.1600	Ø32	112	74	1.600
126.K38.0400	Ø38	140	80	400
126.K38.0600	Ø38	140	80	600
126.K38.0800	Ø38	140	80	800
126.K38.1000	Ø38	140	80	1.000
126.K38.1200	Ø38	140	80	1.200
126.K38.1400	Ø38	140	80	1.400
126.K38.1600	Ø38	140	80	1.600
126.K38.1800	Ø38	140	80	1.800
126.K38.2000	Ø38	140	80	2.000
126.K38.2200	Ø38	140	80	2.200

<sup>1)</sup> Inkl. montagesæt for glas



## Metropol SQ T-hank

børstet rustfrit stål AISI 304, sæt

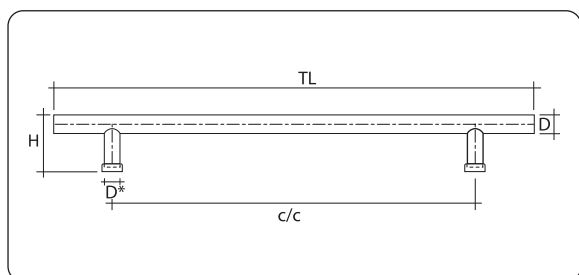

Varenummer <sup>1)</sup>	D	D*	H	TL	C/C
126.SQ30.0400.0600	30 x 30	25 x 25	82	600	400
126.SQ30.0600.0800	30 x 30	25 x 25	82	800	600
126.SQ30.0800.1000	30 x 30	25 x 25	82	1.000	800
126.SQ30.1000.1200	30 x 30	25 x 25	82	1.200	1.000
126.SQ30.1200.1400	30 x 30	25 x 25	82	1.400	1.200
126.SQ30.1400.1600	30 x 30	25 x 25	82	1.600	1.400
126.SQ30.1600.1800	30 x 30	25 x 25	82	1.800	1.600

<sup>1)</sup> Inkl. montagesæt for glas

## Metropol SQ3 T-hank

børstet rustfrit stål AISI 304, sæt

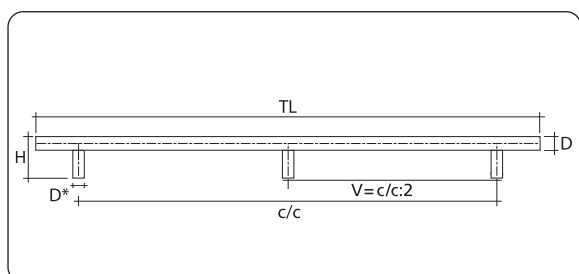

Varenummer <sup>1)</sup>	D	D*	H	TL	C/C
126.SQ30.1000.1200.3	30 x 30	25 x 25	82	1.200	1.000
126.SQ30.1200.1400.3	30 x 30	25 x 25	82	1.400	1.200
126.SQ30.1400.1600.3	30 x 30	25 x 25	82	1.600	1.400
126.SQ30.1600.1800.3	30 x 30	25 x 25	82	1.800	1.600
126.SQ30.1800.2000.3	30 x 30	25 x 25	82	2.000	1.800
126.SQ30.2000.2200.3	30 x 30	25 x 25	82	2.200	2.000
126.SQ30.2200.2400.3	30 x 30	25 x 25	82	2.400	2.200

<sup>1)</sup> Inkl. montagesæt for glas

## Metropol SQ4 T-hank

børstet rustfrit stål AISI 304, sæt

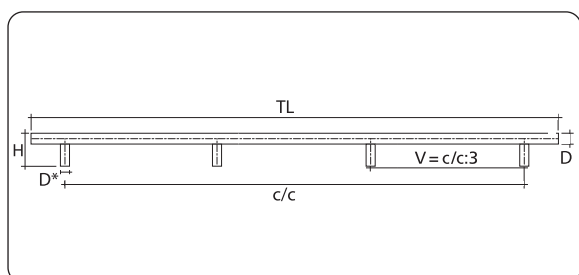

Varenummer <sup>1)</sup>	D	D*	H	TL	C/C
126.SQ30.1600.1800.4	30 x 30	25 x 25	82	1.800	1.600
126.SQ30.1800.2000.4	30 x 30	25 x 25	82	2.000	1.800
126.SQ30.2000.2200.4	30 x 30	25 x 25	82	2.200	2.000
126.SQ30.2200.2400.4	30 x 30	25 x 25	82	2.400	2.200
126.SQ30.2400.2600.4	30 x 30	25 x 25	82	2.600	2.400

<sup>1)</sup> Inkl. montagesæt for glas



## Metropol SO T-hank

børstet rustfrit stål AISI 304, sæt

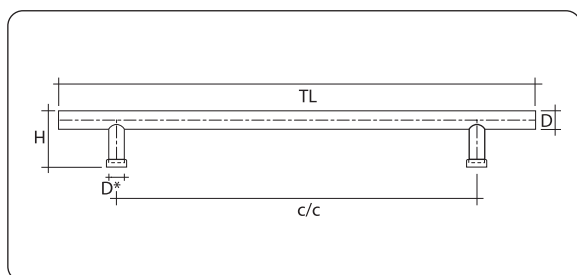

Fixing M

Varenummer <sup>1)</sup>	D	D*	H	TL	C/C
126.T19.0250.0350	Ø19	Ø16	71	350	250
126.T19.0300.0400	Ø19	Ø16	71	400	300
126.T19.0400.0600	Ø19	Ø16	71	600	400
126.T19.0600.0800	Ø19	Ø16	71	800	600
126.T20.0250.0350	Ø20	Ø20	72	350	250
126.T20.0300.0400	Ø20	Ø20	72	400	300
126.T20.0400.0600	Ø20	Ø20	72	600	400
126.T20.0600.0800	Ø20	Ø20	72	800	600
126.T20.0800.1000	Ø20	Ø20	72	1.000	800
126.T25.0300.0400	Ø25	Ø20	77	400	300
126.T25.0400.0600	Ø25	Ø20	77	600	400
126.T25.0600.0800	Ø25	Ø20	77	800	600
126.T25.0800.1000	Ø25	Ø20	77	1.000	800
126.T25.1000.1200	Ø25	Ø20	77	1.200	1.000
126.T25.1200.1400	Ø25	Ø20	77	1.400	1.200
126.T30.0300.0400	Ø30	Ø25	82	400	300
126.T30.0400.0600	Ø30	Ø25	82	600	400
126.T30.0600.0800	Ø30	Ø25	82	800	600
126.T30.0800.1000	Ø30	Ø25	82	1.000	800
126.T30.1000.1200	Ø30	Ø25	82	1.200	1.000
126.T30.1200.1400	Ø30	Ø25	82	1.400	1.200
126.T30.1400.1600	Ø30	Ø25	82	1.600	1.400
126.T30.1600.1800	Ø30	Ø25	82	1.800	1.600
126.T32.0300.0400	Ø32	Ø25	84	400	300
126.T32.0400.0600	Ø32	Ø25	84	600	400
126.T32.0600.0800	Ø32	Ø25	84	800	600
126.T32.0800.1000	Ø32	Ø25	84	1.000	800
126.T32.1000.1200	Ø32	Ø25	84	1.200	1.000
126.T32.1200.1400	Ø32	Ø25	84	1.400	1.200
126.T32.1400.1600	Ø32	Ø25	84	1.600	1.400
126.T32.1600.1800	Ø32	Ø25	84	1.800	1.600
126.T38.0400.0600	Ø38	Ø25	90	600	400
126.T38.0600.0800	Ø38	Ø25	90	800	600
126.T38.0800.1000	Ø38	Ø25	90	1.000	800
126.T38.1000.1200	Ø38	Ø25	90	1.200	1.000
126.T38.1200.1400	Ø38	Ø25	90	1.400	1.200
126.T38.1400.1600	Ø38	Ø25	90	1.600	1.400
126.T38.1600.1800	Ø38	Ø25	90	1.800	1.600
126.T38.1800.2000	Ø38	Ø25	90	2.000	1.800
126.T38.2000.2200	Ø38	Ø25	90	2.200	2.000
126.T38.2200.2400	Ø38	Ø25	90	2.400	2.200

<sup>1)</sup> Inkl. montagesæt for glas



## Metropol S3 T-hank

børstet rustfrit stål AISI 304, sæt

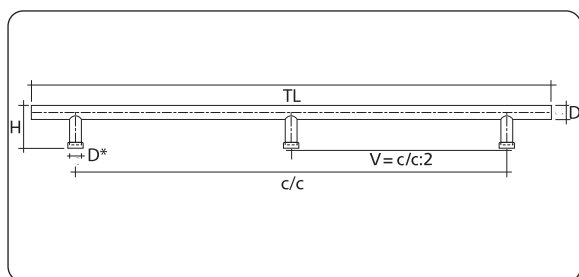

Varenummer <sup>1</sup>	D	D*	H	TL	C/C
126.T20.1000.1200.3	Ø20	Ø20	72	1.200	1.000
126.T20.1200.1400.3	Ø20	Ø20	72	1.400	1.200
126.T20.1400.1600.3	Ø20	Ø20	72	1.600	1.400
126.T20.1600.1800.3	Ø20	Ø20	72	1.800	1.600
126.T30.1000.1200.3	Ø30	Ø25	82	1.200	1.000
126.T30.1200.1400.3	Ø30	Ø25	82	1.400	1.200
126.T30.1400.1600.3	Ø30	Ø25	82	1.600	1.400
126.T30.1600.1800.3	Ø30	Ø25	82	1.800	1.600
126.T30.1800.2000.3	Ø30	Ø25	82	2.000	1.800
126.T30.2000.2200.3	Ø30	Ø25	82	2.200	2.000
126.T30.2200.2400.3	Ø30	Ø25	82	2.400	2.200
126.T38.1200.1400.3	Ø38	Ø30	90	1.400	1.200
126.T38.1400.1600.3	Ø38	Ø30	90	1.600	1.400
126.T38.1600.1800.3	Ø38	Ø30	90	1.800	1.600
126.T38.1800.2000.3	Ø38	Ø30	90	2.000	1.800
126.T38.2000.2200.3	Ø38	Ø30	90	2.200	2.000
126.T38.2200.2400.3	Ø38	Ø30	90	2.400	2.200
126.T38.2400.2600.3	Ø38	Ø30	90	2.600	2.400

<sup>1)</sup> Inkl. montagesæt for glas

## Metropol S4 T-hank

børstet rustfrit stål AISI 304, sæt

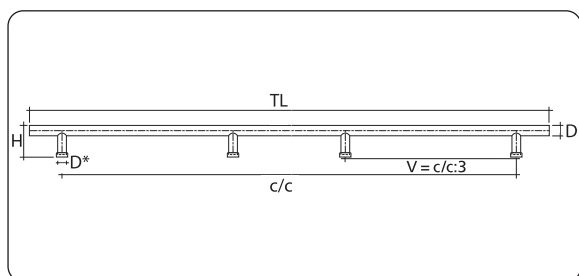

Varenummer <sup>1</sup>	D	D*	H	TL	C/C
126.T25.1400.1600.4	Ø25	Ø20	77	1.600	1.400
126.T25.1600.1800.4	Ø25	Ø20	77	1.800	1.600
126.T25.1800.2000.4	Ø25	Ø20	77	2.000	1.800
126.T25.2000.2200.4	Ø25	Ø20	77	2.200	2.000
126.T25.2200.2400.4	Ø25	Ø20	77	2.400	2.200
126.T25.2400.2600.4	Ø25	Ø20	77	2.600	2.400
126.T30.1600.1800.4	Ø30	Ø25	82	1.800	1.600
126.T30.1800.2000.4	Ø30	Ø25	82	2.000	1.800
126.T30.2000.2200.4	Ø30	Ø25	82	2.200	2.000
126.T30.2200.2400.4	Ø30	Ø25	82	2.400	2.200
126.T30.2400.2600.4	Ø30	Ø25	82	2.600	2.400
126.T38.1600.1800.4	Ø38	Ø30	90	1.800	1.600
126.T38.1800.2000.4	Ø38	Ø30	90	2.000	1.800
126.T38.2000.2200.4	Ø38	Ø30	90	2.200	2.000
126.T38.2200.2400.4	Ø38	Ø30	90	2.400	2.200
126.T38.2400.2600.4	Ø38	Ø30	90	2.600	2.400

<sup>1)</sup> Inkl. montagesæt for glas



## City SLK T-hank

børstet rustfrit stål AISI 304, sæt

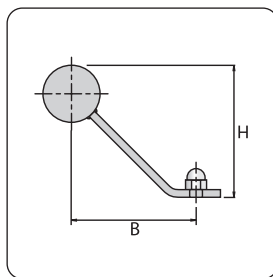
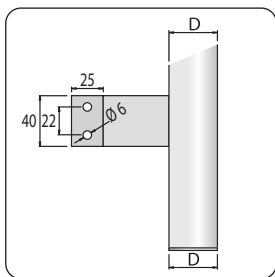
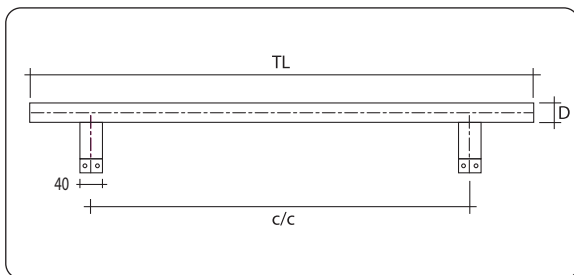

Varenummer	D	D*	B	H	TL	C/C
126.S32.0600.0800	Ø32	Ø40	80	82	800	600
126.S32.0800.1000	Ø32	Ø40	80	82	1.000	800
126.S32.1000.1200	Ø32	Ø40	80	82	1.200	1.000
126.S32.1200.1400	Ø32	Ø40	80	82	1.400	1.200
126.S32.1400.1600	Ø32	Ø40	80	82	1.600	1.400
126.S32.1600.1800	Ø32	Ø40	80	82	1.800	1.600
126.S32.1800.2000	Ø32	Ø40	80	82	2.000	1.800
126.S38.0600.0800	Ø38	Ø40	83	88	800	600
126.S38.0800.1000	Ø38	Ø40	83	88	1.000	800
126.S38.1000.1200	Ø38	Ø40	83	88	1.200	1.000
126.S38.1200.1400	Ø38	Ø40	83	88	1.400	1.200
126.S38.1400.1600	Ø38	Ø40	83	88	1.600	1.400
126.S38.1600.1800	Ø38	Ø40	83	88	1.800	1.600
126.S38.1800.2000	Ø38	Ø40	83	88	2.000	1.800
126.S38.2000.2200	Ø38	Ø40	83	88	2.200	2.000
126.S38.2200.2400	Ø38	Ø40	83	88	2.400	2.200

<sup>1)</sup> Inkl. montagesæt for glas

## City SLK3 T-hank

børstet rustfrit stål AISI 304, sæt

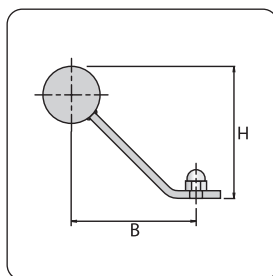
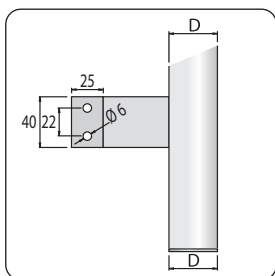
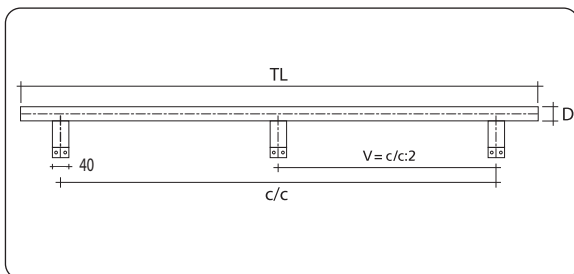

Varenummer	D	D*	B	H	TL	C/C
126.S32.1000.1200.3	Ø32	Ø40	80	82	1.200	1.000
126.S32.1200.1400.3	Ø32	Ø40	80	82	1.400	1.200
126.S32.1400.1600.3	Ø32	Ø40	80	82	1.600	1.400
126.S32.1600.1800.3	Ø32	Ø40	80	82	1.800	1.600
126.S32.1800.2000.3	Ø32	Ø40	80	82	2.000	1.800
126.S32.2000.2200.3	Ø32	Ø40	80	82	2.200	2.000
126.S32.2200.2400.3	Ø32	Ø40	80	82	2.400	2.200
126.S32.2400.2600.3	Ø32	Ø40	80	82	2.600	2.400
126.S38.1200.1400.3	Ø38	Ø40	83	88	1.400	1.200
126.S38.1400.1600.3	Ø38	Ø40	83	88	1.600	1.400
126.S38.1600.1800.3	Ø38	Ø40	83	88	1.800	1.600
126.S38.1800.2000.3	Ø38	Ø40	83	88	2.000	1.800
126.S38.2000.2200.3	Ø38	Ø40	83	88	2.200	2.000
126.S38.2200.2400.3	Ø38	Ø40	83	88	2.400	2.200
126.S38.2400.2600.3	Ø38	Ø40	83	88	2.600	2.400

<sup>1)</sup> Inkl. montagesæt for glas



## City SLK4 T-hank

børstet rustfrit stål AISi 304, sæt

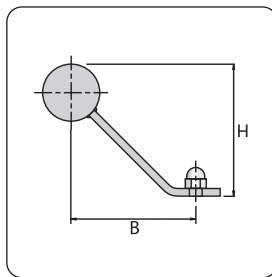
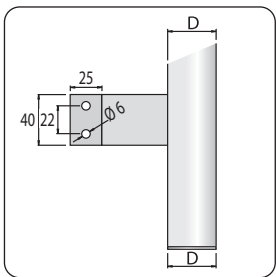
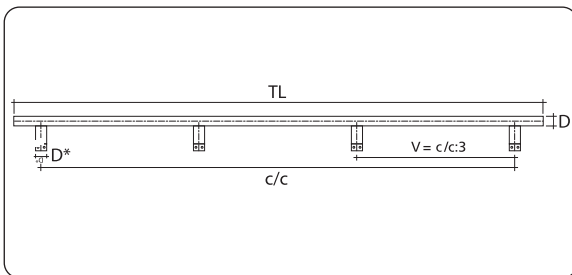

Varenummer <sup>1</sup>	D	D*	B	H	TL	C/C
126.S32.1600.1800.4	Ø32	Ø40	80	82	1.800	1.600
126.S32.1800.2000.4	Ø32	Ø40	80	82	2.000	1.800
126.S32.2000.2200.4	Ø32	Ø40	80	82	2.200	2.000
126.S32.2200.2400.4	Ø32	Ø40	80	82	2.400	2.200
126.S32.2400.2600.4	Ø32	Ø40	80	82	2.600	2.400
126.S38.1600.1800.4	Ø38	Ø40	83	88	1.800	1.600
126.S38.1800.2000.4	Ø38	Ø40	83	88	2.000	1.800
126.S38.2000.2200.4	Ø38	Ø40	83	88	2.200	2.000
126.S38.2200.2400.4	Ø38	Ø40	83	88	2.400	2.200
126.S38.2400.2600.4	Ø38	Ø40	83	88	2.600	2.400

<sup>1</sup> Inkl. montagesæt for glas

8





## Stylish SC T-hank med vinkelben

børstet rustfrit stål AISI 304, sæt

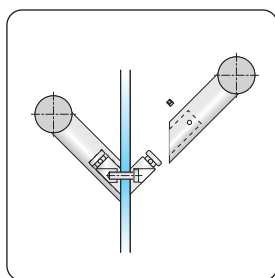
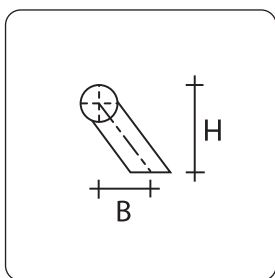
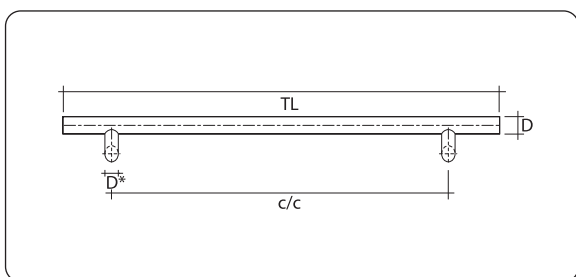

Varenummer <sup>1)</sup>	D	D*	B	H	TL	C/C
126.V32.0400.0600	Ø32	Ø25	60	84	600	400
126.V32.0600.0800	Ø32	Ø25	60	84	800	600
126.V32.0800.1000	Ø32	Ø25	60	84	1.000	800
126.V32.1000.1200	Ø32	Ø25	60	84	1.200	1.000
126.V32.1200.1400	Ø32	Ø25	60	84	1.400	1.200
126.V32.1400.1600	Ø32	Ø25	60	84	1.600	1.400
126.V32.1600.1800	Ø32	Ø25	60	84	1.800	1.600
126.V38.0600.0800	Ø38	Ø30	63	90	800	600
126.V38.0800.1000	Ø38	Ø30	63	90	1.000	800
126.V38.1000.1200	Ø38	Ø30	63	90	1.200	1.000
126.V38.1200.1400	Ø38	Ø30	63	90	1.400	1.200
126.V38.1400.1600	Ø38	Ø30	63	90	1.600	1.400
126.V38.1600.1800	Ø38	Ø30	63	90	1.800	1.600
126.V38.1800.2000	Ø38	Ø30	63	90	2.000	1.800
126.V38.2000.2200	Ø38	Ø30	63	90	2.200	2.000
126.V38.2200.2400	Ø38	Ø30	63	90	2.400	2.200

<sup>1)</sup> Inkl. montagesæt for glas

## Stylish SC3 T-hank med vinkelben

børstet rustfrit stål AISI 304, sæt

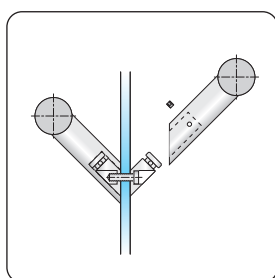
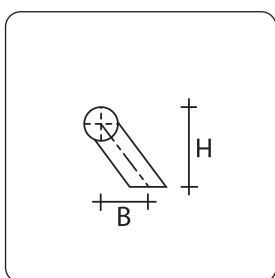
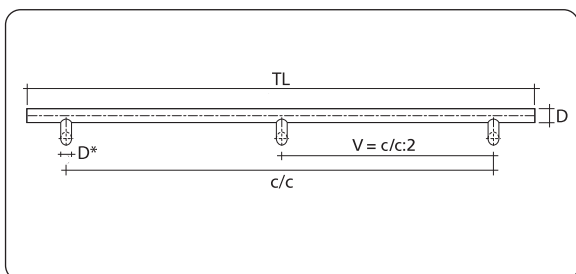

Varenummer <sup>1)</sup>	D	D*	B	H	TL	C/C
126.V32.1000.1200.3	Ø32	Ø25	60	84	1.200	1.000
126.V32.1200.1400.3	Ø32	Ø25	60	84	1.400	1.200
126.V32.1400.1600.3	Ø32	Ø25	60	84	1.600	1.400
126.V32.1600.1800.3	Ø32	Ø25	60	84	1.800	1.600
126.V32.1800.2000.3	Ø32	Ø25	60	84	2.000	1.800
126.V32.2000.2200.3	Ø32	Ø25	60	84	2.200	2.000
126.V38.1000.1200.3	Ø38	Ø30	63	90	1.200	1.000
126.V38.1200.1400.3	Ø38	Ø30	63	90	1.400	1.200
126.V38.1400.1600.3	Ø38	Ø30	63	90	1.600	1.400
126.V38.1600.1800.3	Ø38	Ø30	63	90	1.800	1.600
126.V38.1800.2000.3	Ø38	Ø30	63	90	2.000	1.800
126.V38.2000.2200.3	Ø38	Ø30	63	90	2.200	2.000
126.V38.2200.2400.3	Ø38	Ø30	63	90	2.400	2.200
126.V38.2400.2600.3	Ø38	Ø30	63	90	2.600	2.400

<sup>1)</sup> Inkl. montagesæt for glas



## Stylish SC4 T-hank med vinkelben

børstet rustfrit stål AISI 304, sæt

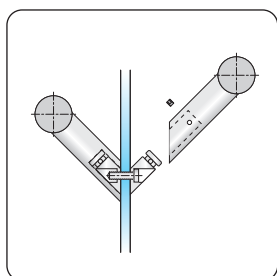
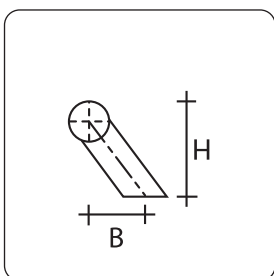
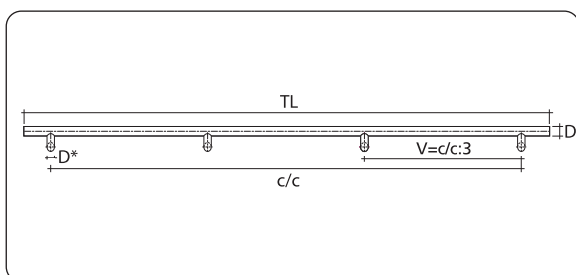

Varenummer	D	D*	B	H	TL	C/C
126.V32.1600.1800.4	Ø32	Ø25	60	82	1.800	1.600
126.V32.1800.2000.4	Ø32	Ø25	60	82	2.000	1.800
126.V32.2000.2200.4	Ø32	Ø25	60	82	2.200	2.000
126.V32.2200.2400.4	Ø32	Ø25	60	82	2.400	2.200
126.V32.2400.2600.4	Ø32	Ø25	60	82	2.600	2.400
126.V38.1600.1800.4	Ø38	Ø30	63	90	1.800	1.600
126.V38.1800.2000.4	Ø38	Ø30	63	90	2.000	1.800
126.V38.2000.2200.4	Ø38	Ø30	63	90	2.200	2.000
126.V38.2200.2400.4	Ø38	Ø30	63	90	2.400	2.200
126.V38.2400.2600.4	Ø38	Ø30	63	90	2.600	2.400

<sup>1)</sup> Inkl. montagesæt for glas

8

## Classic KR cirkelhanke

børstet rustfrit stål AISI 304, sæt

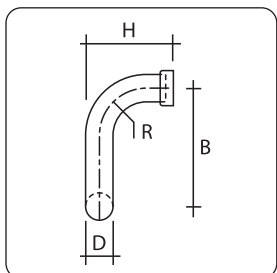
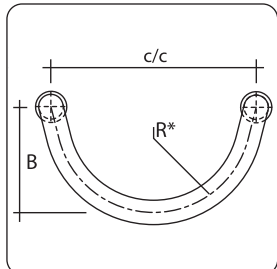

Varenummer <sup>1)</sup>	D	R	H	B	C/C
126.C25.0250	25	43	72	110	250
126.C25.0300	25	43	72	210	300
126.C25.0320	25	43	72	200	320
126.C32.0300	32	56	84	205	300
126.C32.0350	32	56	84	230	350
126.C32.0380	32	56	84	240	380
126.C32.0400	32	56	84	255	400

<sup>1)</sup> Inkl. montagesæt for glas

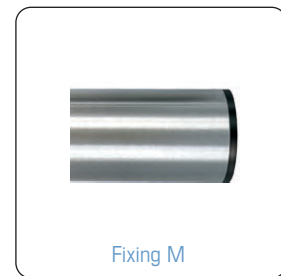

### Metropol P0 T-hank egetræ og børstet rustfrit stål AISI 304, sæt

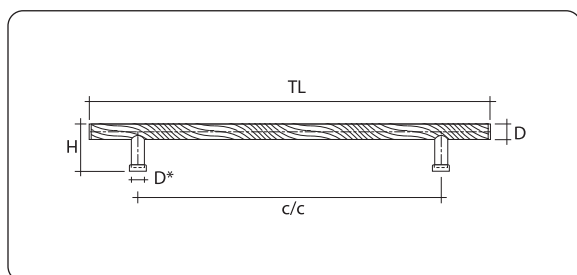

Varenummer	D	D	H	TL	C/C
126.TRT32.0300.0400	Ø32	Ø25	84	400	300
126.TRT32.0400.0600	Ø32	Ø25	84	600	400
126.TRT32.0600.0800	Ø32	Ø25	84	800	600
126.TRT38.0400.0600	Ø38	Ø30	90	600	400
126.TRT38.0600.0800	Ø38	Ø30	90	800	600
126.TRT38.0800.1000	Ø38	Ø30	90	1.000	800
126.TRT38.1000.1200	Ø38	Ø30	90	1.200	1.000

<sup>1)</sup> Inkl. montagesæt for glas

8

### Metropol P3 T-hank egetræ og børstet rustfrit stål AISI 304, sæt

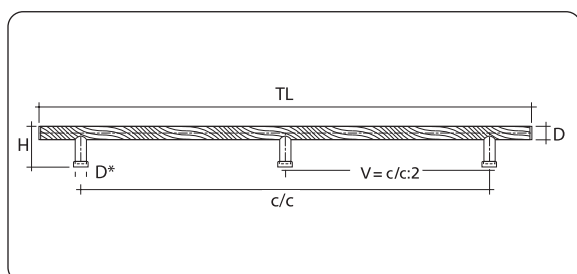

Varenummer	D	D	H	TL	C/C
126.TRT32.3300.0400.3	Ø32	Ø25	84	400	300
126.TRT32.3400.0600.3	Ø32	Ø25	84	600	400
126.TRT32.3600.0800.3	Ø32	Ø25	84	800	600
126.TRT38.3400.0600.3	Ø38	Ø30	90	600	400
126.TRT38.3600.0800.3	Ø38	Ø30	90	800	600
126.TRT38.3800.1000.3	Ø38	Ø30	90	1.000	800
126.TRT38.3100.1200.3	Ø38	Ø30	90	1.200	1.000

<sup>1)</sup> Inkl. montagesæt for glas

### Metropol P4 T-hank egetræ og børstet rustfrit stål AISI 304, sæt

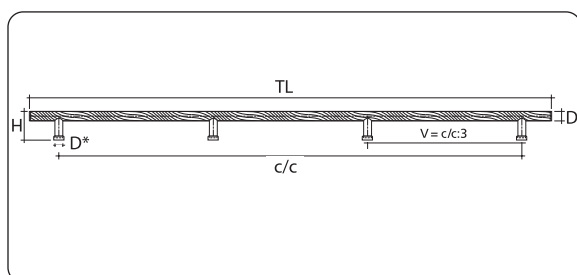

Varenummer	D	D	H	TL	C/C
126.TRT32.1600.1800.4	Ø32	Ø25	84	1.800	1.600
126.TRT32.1800.2000.4	Ø32	Ø25	84	2.000	1.800
126.TRT32.2000.2200.4	Ø32	Ø25	84	2.200	2.000
126.TRT32.2200.2400.4	Ø32	Ø25	84	2.400	2.200
126.TRT32.2400.2600.4	Ø32	Ø25	84	2.600	2.400
126.TRT38.1800.2000.4	Ø38	Ø30	90	2.000	1.800
126.TRT38.2000.2200.4	Ø38	Ø30	90	2.200	2.000
126.TRT38.2200.2400.4	Ø38	Ø30	90	2.400	2.200
126.TRT38.2400.2600.4	Ø38	Ø30	90	2.600	2.400

<sup>1)</sup> Inkl. montagesæt for glas

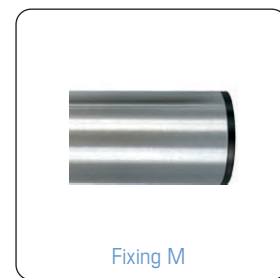

## Majestic PRLS T-hank egetræ og børstet rustfrit stål AISI 304, sæt

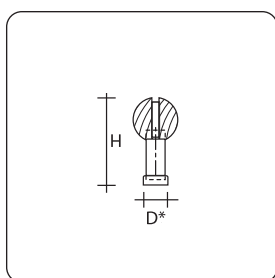
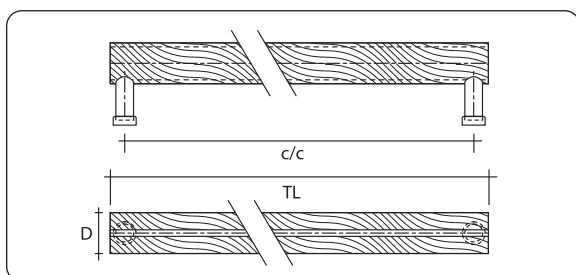

Varenummer <sup>1)</sup>	D	D	H	TL	C/C
126.TRT50.2000.2040	Ø50	Ø30	92	2.040	2.000
126.TRT50.2200.2240	Ø50	Ø30	92	2.240	2.200
126.TRT50.2400.2440	Ø50	Ø30	92	2.440	2.400

<sup>1)</sup> Inkl. montagesæt for glas

8



## Majestic PQLS T-hank egetræ og børstet rustfrit stål AISI 304, sæt

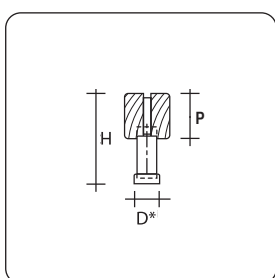
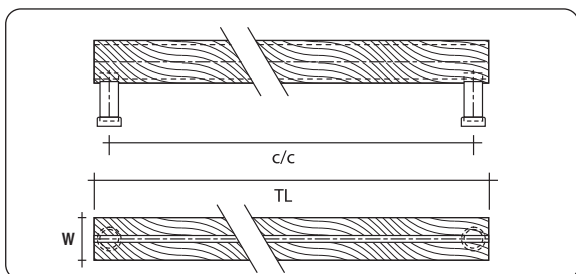

Varenummer <sup>1)</sup>	W	P	D	H	TL	C/C
126.TRTSQ.2000.2040	50	50	30	92	2.040	2.000
126.TRTSQ.2200.2240	50	50	30	92	2.240	2.200
126.TRTSQ.2400.2440	50	50	30	92	2.440	2.400

<sup>1)</sup> Inkl. montagesæt for glas

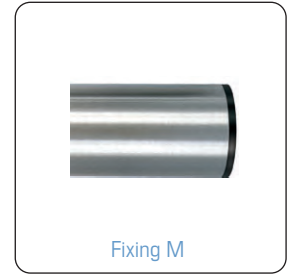

## Metropol Wooden PP

egetræ, sæt

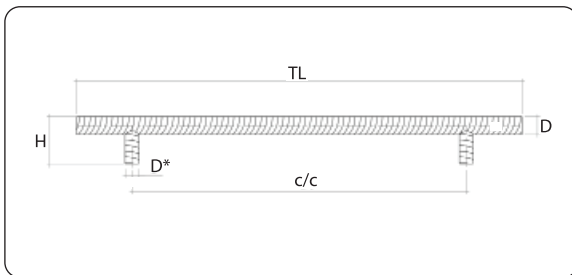

Varenummer	D	D	H	TL	C/C
126.TT32.0300.0400	Ø32	Ø25	82	400	300
126.TT32.0400.0600	Ø32	Ø25	82	600	400
126.TT32.0600.0800	Ø32	Ø25	82	800	600
126.TT38.0400.0600	Ø38	Ø30	88	600	400
126.TT38.0600.0800	Ø38	Ø30	88	800	600
126.TT38.0800.1000	Ø38	Ø30	88	1.000	800
126.TT38.1000.1200	Ø38	Ø30	88	1.200	1.000

<sup>1)</sup> Inkl. montagesæt for glas

8

## Metropol Wooden PP3

egetræ, sæt

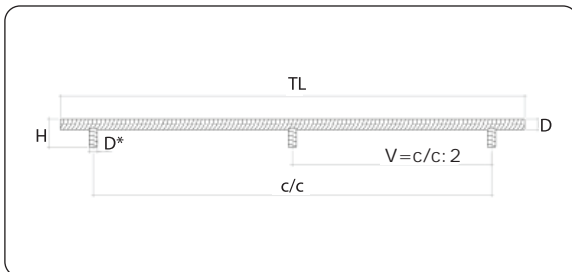

Varenummer	D	D	H	TL	C/C
126.TT32.1000.1200.3	Ø32	Ø25	92	1.200	1.000
126.TT32.1200.1400.3	Ø32	Ø25	92	1.400	1.200
126.TT32.1400.1600.3	Ø32	Ø25	92	1.600	1.400
126.TT38.1200.1400.3	Ø38	Ø30	98	1.400	1.200
126.TT38.1400.1600.3	Ø38	Ø30	98	1.600	1.400
126.TT38.1600.1800.3	Ø38	Ø30	98	1.800	1.600
126.TT38.1800.2000.3	Ø38	Ø30	98	2.000	1.800
126.TT38.2000.2200.3	Ø38	Ø30	98	2.200	2.000

<sup>1)</sup> Inkl. montagesæt for glas

## Metropol Wooden PP4

egetræ, sæt

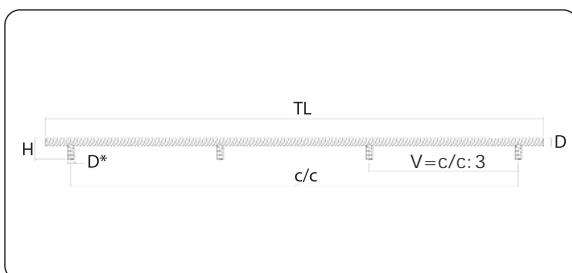

Varenummer	D	D	H	TL	C/C
126.TT32.1600.1800.4	Ø32	Ø25	92	1.800	1.600
126.TT32.1800.2000.4	Ø32	Ø25	92	2.000	1.800
126.TT32.2000.2200.4	Ø32	Ø25	92	2.200	2.000
126.TT32.2200.2400.4	Ø32	Ø25	92	2.400	2.200
126.TT32.2400.2600.4	Ø32	Ø25	92	2.600	2.400
126.TT38.1800.2000.4	Ø38	Ø30	98	2.000	1.800
126.TT38.2000.2200.4	Ø38	Ø30	98	2.200	2.000
126.TT38.2200.2400.4	Ø38	Ø30	98	2.400	2.200
126.TT38.2400.2600.4	Ø38	Ø30	98	2.600	2.400

<sup>1)</sup> Inkl. montagesæt for glas

## Diamantek dørhanke i rustfrit stål

Diamantek standard hanke er fremstillet i børstet rustfrit stål og til dobbeltdøre. Hankene anvendes til glastykkelse mellem 5 - 25 mm eller dørtykkelse fra 25 - 70 mm. Med standard hankene følger et stilfuldt rundt fastgøringsbeslag som vist ved produktet.

For at imødekomme kundens ønsker og behov, fremstiller Diamantek dørhanke ud over standard produkterne som er vist i dette katalog.

Diamanteks specialfremstillede dørhanke giver mulighed for at vælge hanke i poleret rustfrit stål, dørtykkelse op til 100 mm og en bred vifte af runde og sekskantede fastgøringsbeslag.



### Standard fastgøringsbeslag og for montage i glas



Fixing M

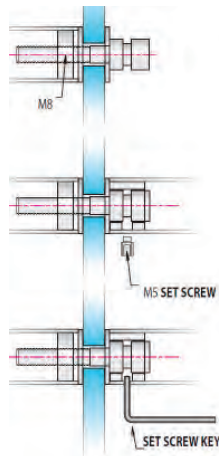

### Alternative fastgøringsbeslag og montage muligheder i glas, metal og træ



Fixing V



Fixing S



Fixing O



Fixing K



Fixing X

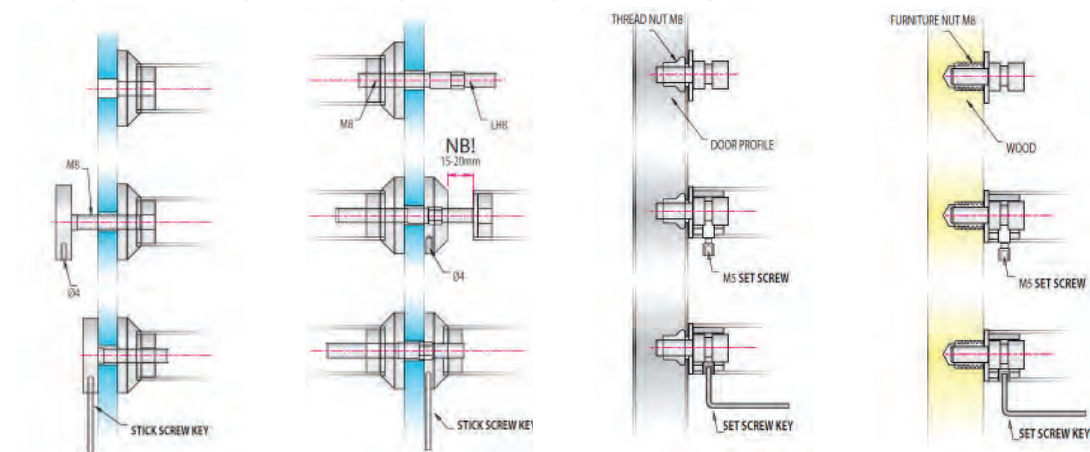

### Plade fastgøringsbeslag for enkelt/ dobbelt side



Fixing FD

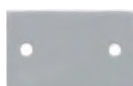

Fixing F



Fixing F

### Montage muligheder med pladefastgørelse





## Dørhanke • Dorma Glas

Produktoversigt . . . . . 4

Rustfrit stål:

T-hanke . . . . .	30
Beyond . . . . .	31
Arcos . . . . .	31
T-hank med lås . . . . .	32

### Dorma Glas

Virksomheden er kendt for deres høj kvalitets portefølje inden for dørteknik, sikkerhedsløsninger og glasbeslag til hoteller, butikker, lufthavne, kontorer og private hjem.

I 2015 fusionerede tyske Dorma og schwiziske Kaba Group til Dormakaba, som stærkt komplimenterer hinanden i branchen.

## Manet T-hank med samlebolt, sæt, matbørstet rustfrit stål AISI 316

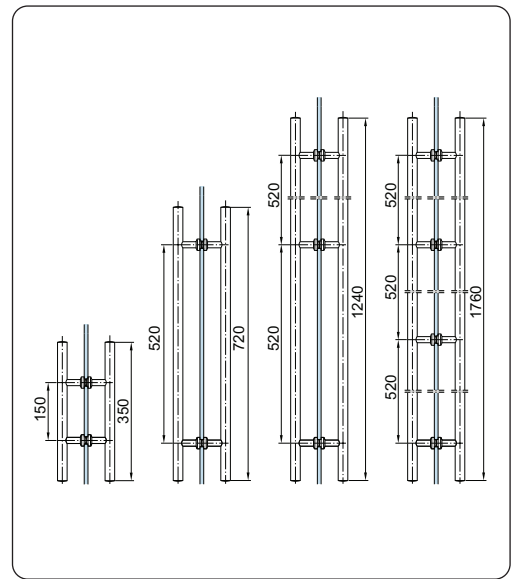
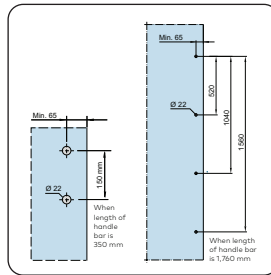
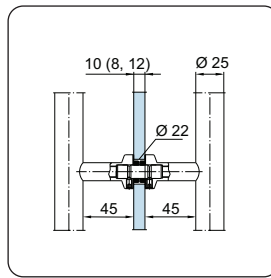
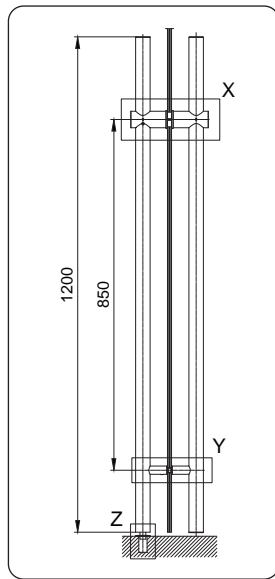

Varenummer	Ø	TL	ben	glashul	for glas	C/C
100.821.247.700	Ø25	350	2 stk.	Ø22 mm	8 - 12 mm	150
100.821.250.700	Ø25	720	2 stk.	Ø22 mm	8 - 12 mm	520
100.821.253.700	Ø25	1.240	3 stk.	Ø22 mm	8 - 12 mm	520
100.821.256.700	Ø25	1.760	4 stk.	Ø22 mm	8 - 12 mm	520

8

## Manet T-hank for enkeltsidet montage, matbørstet rustfrit stål AISI 316

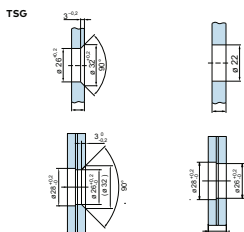
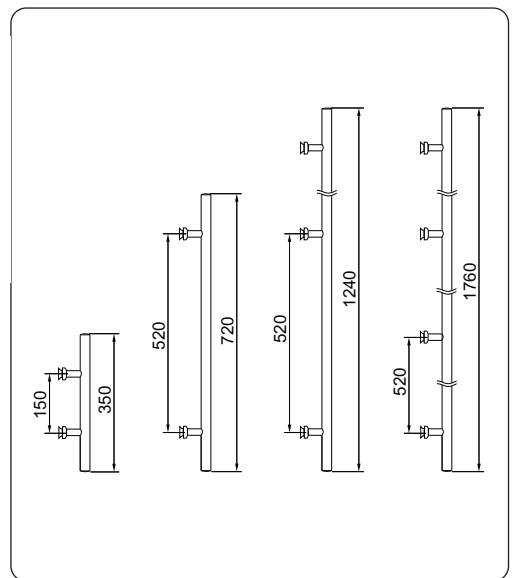
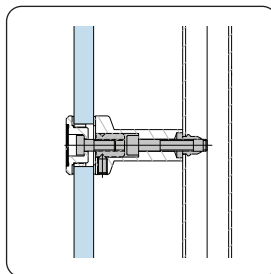
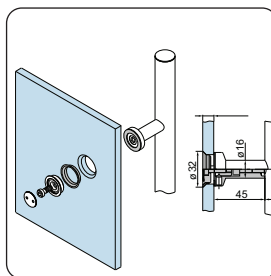
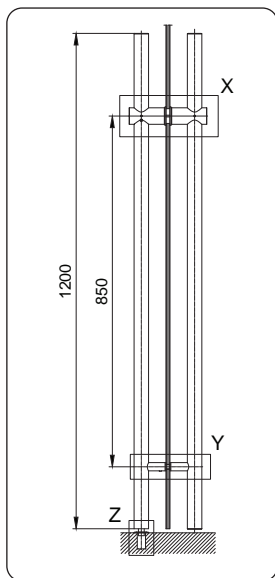

Varenummer	Ø	TL	ben	Glashul	for glas	C/C
100.821.240.700	Ø25	350	2 stk.	303	8 - 12 mm	150
100.821.241.700	Ø25	720	2 stk.	303	8 - 12 mm	520
100.821.281.700	Ø25	720	2 stk.	316	8 - 12 mm	520
100.821.242.700	Ø25	1.240	3 stk.	303	8 - 12 mm	520
100.821.243.700	Ø25	1.760	4 stk.	303	8 - 12 mm	520
100.821.283.700	Ø25	1.760	4 stk.	316	8 - 12 mm	520

## Beyond geringshank med samlebolt, 2 ben, aluminium, sæt

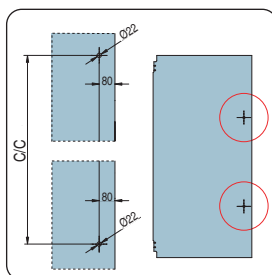
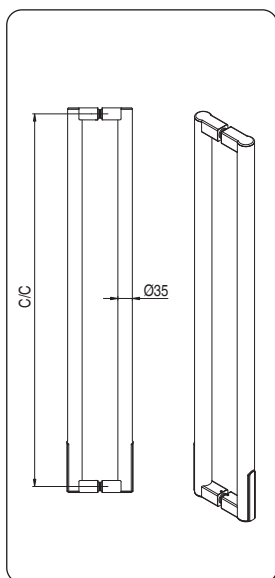

Varenummer	D	TL	overflade	for glas	C/C
100.830.300.107	Ø35	479	RS-look	10 - 12 mm	450
100.830.300.114	Ø35	479	satin elox.	10 - 12 mm	450
100.830.305.107	Ø35	629	RS-look	10 - 12 mm	600
100.830.305.114	Ø35	629	satin elox.	10 - 12 mm	600
100.830.310.107	Ø35	929	RS-look	10 - 12 mm	600
100.830.310.114	Ø35	929	satin elox.	10 - 12 mm	900

8

## Arcos u-hank for 8 - 12 mm, 2 ben, aluminium, sæt

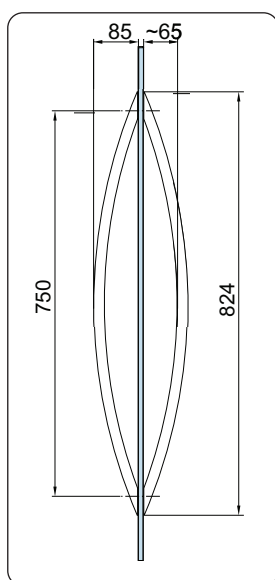

<sup>1)</sup> Inkl. montagesæt for glas

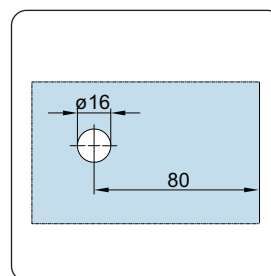
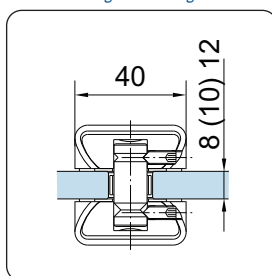

Varenummer	D	TL	overflade	for glas	C/C
100.826.500.114	Ø25	398	satin el ox.	8 - 12 mm	350
100.826.500.126	Ø25	398	matbørstet	8 - 12 mm	350
100.826.500.127	Ø25	398	poleret	8 - 12 mm	350
100.826.510.114	Ø25	824	satin elox.	8 - 12 mm	750
100.826.510.126	Ø25	824	matbørstet	8 - 12 mm	750
100.826.510.127	Ø25	824	poleret	8 - 12 mm	750

## T-hank med lås for 8-12 mm glas, sæt, matbørstet rustfrit stål

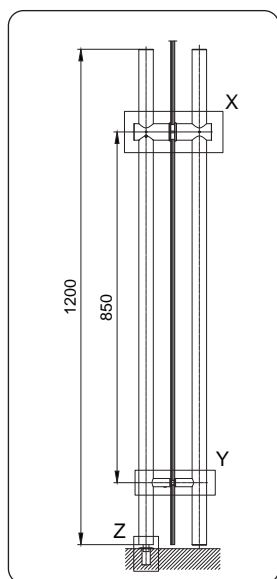

Varenummer	Ø	TL	ben	aflåsning	glashul
100.821.581.700	Ø35	1.200	2 stk.	enkelt-sided	Ø 12 mm
100.821.580.700	Ø35	1.200	2 stk.	dobbelt-sided	Ø 12 mm

Enkelt-sided

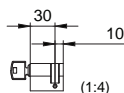

Dobbelt-sided

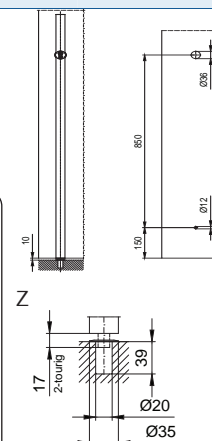
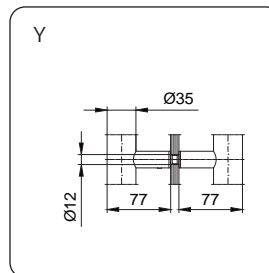
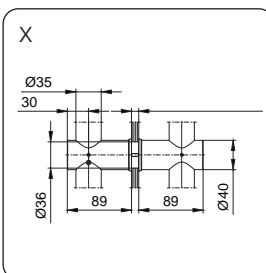
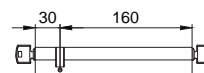

8



## Dørhanke • Normbau

Produktoversigt . . . . . 4

Rustfrit stål:

U-hanke . . . . .	34
T-hanke . . . . .	35
Gerinsuhank . . . . .	35
Forkrøppet hanke . . . . .	36
Cirkelhanke . . . . .	36
Montagesæt . . . . .	37

8

### Normbau

Siden 1954 har den familiejet virksomhed Normbau produceret arkitektonisk hardware, elektroniske adgangskontroller og interiør systemer. De har fokus på produktudvikling og nyskabelse af høj kvalitets produkter med innovative features. Siden 2013 har Normbau været en del af Allegion group, som også producere hardware for hospitaler og andre service erhverv.



## Type 22 U-hank, matbørstet rustfrit stål 316

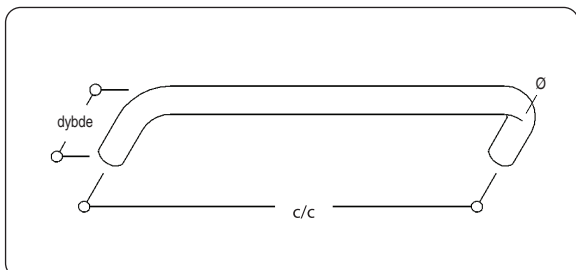

Varenummer <sup>1)</sup>	diameter	dybde	AISI	TL	C/C
183.U20.0120	Ø20 mm	69	316	140	120
183.U20.0200	Ø20 mm	69	316	220	200
183.U20.0300	Ø20 mm	69	316	320	300
183.U20.0350	Ø20 mm	69	316	370	350
183.U20.0400	Ø20 mm	69	316	420	400
183.U20.0500	Ø20 mm	69	316	520	500
183.U26.0200	Ø26 mm	85	316	220	200
183.U26.0300	Ø26 mm	85	316	320	300
183.U26.0350	Ø26 mm	85	316	370	350
183.U26.0400	Ø26 mm	85	316	420	400
183.U32.0200	Ø32 mm	88	316	220	200
183.U32.0300	Ø32 mm	88	316	320	300
183.U32.0350	Ø32 mm	88	316	370	350
183.U32.0400	Ø32 mm	88	316	420	400

<sup>1)</sup> Kan leveres i længder op til 2.650 mm

<sup>2)</sup> Montagesæt findes på side 37



**NORMBAU**



## Type 122 T-hank, matbørstet rustfrit stål 316

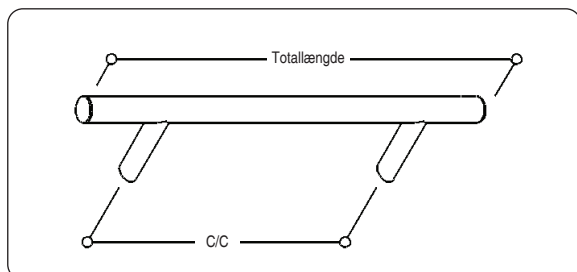

Varenummer <sup>1)</sup>	diameter	Ben	TL	Dybde	C/C
183.T20.0150.0300	Ø20 mm	2 stk.	300	69	150
183.T20.0200.0400	Ø20 mm	2 stk.	400	69	200
183.T26.0150.0350	Ø26 mm	2 stk.	350	85	150
183.T26.0200.0400	Ø26 mm	2 stk.	400	85	200
183.T26.0300.0500	Ø26 mm	2 stk.	500	85	300
183.T26.0400.0600	Ø26 mm	2 stk.	600	85	400
183.T26.0500.0700	Ø26 mm	2 stk.	700	85	500
183.T26.0600.0800	Ø26 mm	2 stk.	800	85	600
183.T26.0800.1000	Ø26 mm	2 stk.	1.000	85	800
183.T26.1000.1200	Ø26 mm	2 stk.	1.200	85	1.000
183.T32.0150.0350	Ø32 mm	2 stk.	350	88	150
183.T32.0200.0400	Ø32 mm	2 stk.	400	88	200
183.T32.0300.0500	Ø32 mm	2 stk.	500	88	300
183.T32.0400.0600	Ø32 mm	2 stk.	600	88	400
183.T32.0500.0700	Ø32 mm	2 stk.	700	88	500
183.T32.0600.0800	Ø32 mm	2 stk.	800	88	600
183.T32.0800.1000	Ø32 mm	2 stk.	1.000	88	800
183.T32.1000.1200	Ø32 mm	2 stk.	1.200	88	1.000
183.T32.1200.1400	Ø32 mm	2 stk.	1.400	88	1.200
183.T32.1400.1600	Ø32 mm	2 stk.	1.600	88	1.400

<sup>1)</sup> Kan leveres i længder op til 2.650 mm

<sup>2)</sup> Normbau Type 122, montagesæt findes på side 37

## Type 222 geringshank, matbørstet rustfrit stål

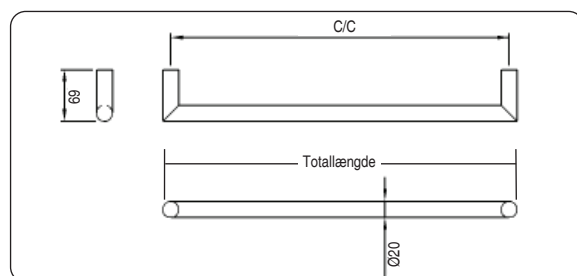

Varenummer	diameter	dybde	AISI	TL	C/C
183.G20.0200	Ø20 mm	69	316	220	200
183.G20.0300	Ø20 mm	69	316	320	300
183.G20.0400	Ø20 mm	69	316	420	400

<sup>1)</sup> Kan leveres i længder fra 200 - 1.250 mm

<sup>2)</sup> Montagesæt findes på side 37

<sup>3)</sup> Ø26, Ø32 og Ø40 mm på bestilling i længder op til 2.650 mm

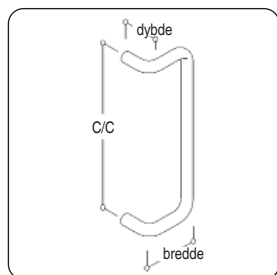
**Type 23** forkrøppet hanke, matbørstet rustfrit stål 316

Varenummer <sup>1</sup>	diameter	bredde	TL	dybde	C/C
183.F20.0200	Ø20 mm	120 mm	220 mm	69 mm	200
183.F20.0300	Ø20 mm	120 mm	320 mm	69 mm	300
183.F20.0350	Ø20 mm	120 mm	370 mm	69 mm	350
183.F20.0400	Ø20 mm	120 mm	420 mm	69 mm	400
183.F20.0500	Ø20 mm	120 mm	520 mm	69 mm	500
183.F20.0650	Ø20 mm	120 mm	670 mm	69 mm	650
183.F26.0200	Ø26 mm	120 mm	226 mm	85 mm	200
183.F26.0300	Ø26 mm	120 mm	326 mm	85 mm	300
183.F26.0350	Ø26 mm	120 mm	376 mm	85 mm	350
183.F26.0400	Ø26 mm	120 mm	426 mm	85 mm	400
183.F32.0200	Ø30 mm	120 mm	230 mm	88 mm	200
183.F32.0300	Ø30 mm	120 mm	330 mm	88 mm	300
183.F32.0350	Ø30 mm	120 mm	380 mm	88 mm	350
183.F32.0400	Ø30 mm	120 mm	430 mm	88 mm	400

<sup>1)</sup> Kan laves i længder op til 650 mm. Type Ø32 - Ø40 mm på bestilling i længder op til 2.650 mm

<sup>2)</sup> Montagesæt findes på side 37

8

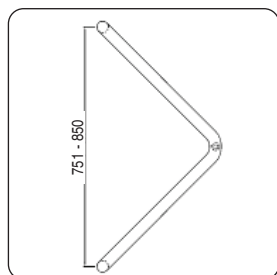
**Type 24** forkrøppet hanke, matbørstet rustfrit stål 316

Varenummer <sup>1</sup>	diameter	bredde	TL	dybde	C/C
183.V26.0300	Ø26 mm	160 mm	326 mm	85 mm	300
183.V26.0350	Ø26 mm	185 mm	376 mm	85 mm	350
183.V32.0300	Ø32 mm	165 mm	332 mm	88 mm	300
183.V32.0300	Ø32 mm	190 mm	382 mm	88 mm	350
183.V32.0300	Ø32 mm	215 mm	432 mm	88 mm	400

<sup>1)</sup> Montagesæt findes på side 37

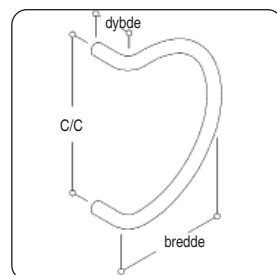
**Type 25** cirkelhanke, matbørstet rustfrit stål 316

Varenummer <sup>1</sup>	diameter	bredde	TL	dybde	C/C
183.C26.0200	Ø26 mm	169 mm	226 mm	85 mm	200
183.C26.0300	Ø26 mm	230 mm	326 mm	85 mm	300
183.C32.0200	Ø32 mm	174 mm	232 mm	88 mm	200
183.C32.0300	Ø32 mm	224 mm	332 mm	88 mm	300
183.C32.0350	Ø32 mm	249 mm	382 mm	88 mm	350
183.C32.0400	Ø32 mm	274 mm	432 mm	88 mm	400

<sup>1)</sup> Montagesæt findes på side 37

## Montagesæt for hanke

### Glasdøre 8-18 mm

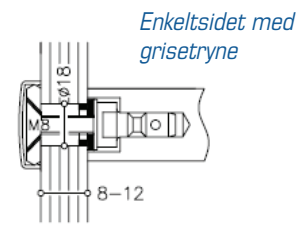
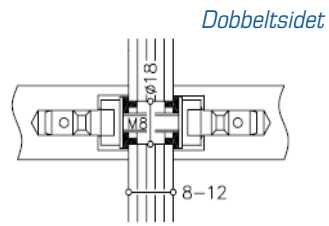

Dørtykkelse	Dobbeltsidet	Enkeltsidet m. grisetryne
8 - 12 mm	183.GD8.128	183.GE8.128

### Massive døre 38-72 mm

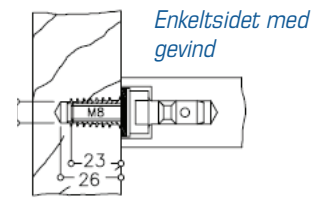
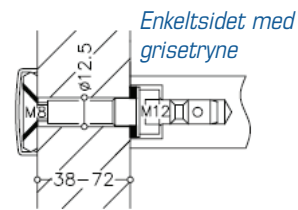
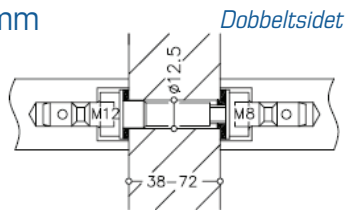

Dørtykkelse	Dobbeltsidet	Enkeltsidet m. grisetryne	Enkeltsidet m. gevind
38 - 72 mm	183.TD3.072	183.TEG.387	183.TEB.387

8



## Dørhanke • Randi

Produktoversigt . . . . . 4

Rustfrit stål:

U-hanke . . . . . 39

Forkrøppet U-hanke . . . . . 39

Montagesæt . . . . . 40

### Randi

Siden 1948 har Randi produceret dørgreb i rustfrit stål, som er blevet anvendt af mange håndværkere igennem tiden, da mange af dem er arkitekttegnede. De er især kendte for deres unikke beslagserier: Randi-Line®, Novo-Line® og Classic-Line®.

I 2014 blev Randi overtaget af den tyske producent ECO Schulte GmbH & Co. KG.



## Randi-line 1512/1513/1514

U-hank, matbørstet AISI 304 rustfrit stål

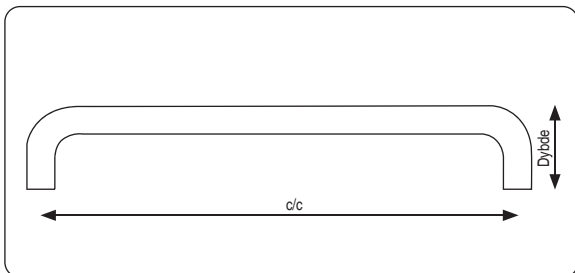

Varenummer	diameter	dybde	længde	C/C
181.U14.0125.*	Ø14 mm	55	139	125
181.U14.0200.*	Ø14 mm	55	214	200
181.U14.0300.*	Ø14 mm	55	314	300
181.U14.0400.*	Ø14 mm	55	414	400
181.U14.0650.*	Ø14 mm	55	664	650
181.U16.0125.*	Ø16 mm	55	141	125
181.U16.0200.*	Ø16 mm	55	216	200
181.U16.0300.*	Ø16 mm	55	316	300
181.U16.0400.*	Ø16 mm	55	416	400
181.U16.0650.*	Ø16 mm	55	666	650
181.U19.0125.*	Ø19 mm	60	144	125
181.U19.0200.*	Ø19 mm	60	219	200
181.U19.0300.*	Ø19 mm	60	319	300
181.U19.0400.*	Ø19 mm	60	419	400
181.U19.0650.*	Ø19 mm	60	669	650

<sup>1)</sup> Montagesæt findes på side 40

<sup>2)</sup> Ved bestilling nævn om der ønskes hul- eller gevinddel

<sup>3)</sup> Ved bestilling af huldell medfølger pinolskrue og MB gevinddel

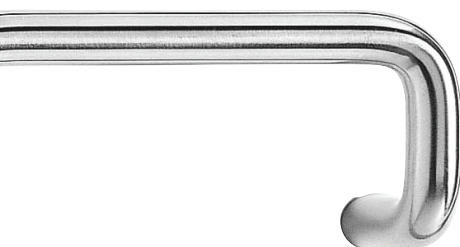

## Randi line 1532/1533/1534

forkrøppet U-hank, matbørstet AISI 304 rustfrit stål

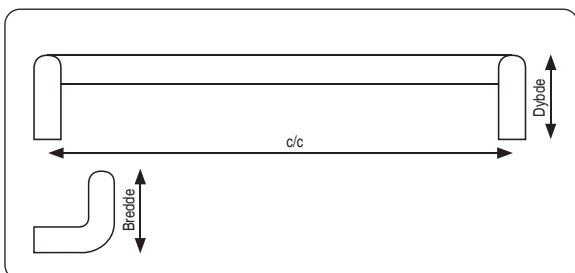

Varenummer	diameter	Dybde	længde	bredde	C/C
181.F14.0125.*	Ø14 mm	55	139	60	125
181.F14.0200.*	Ø14 mm	55	214	60	200
181.F14.0300.*	Ø14 mm	55	314	60	300
181.F14.0400.*	Ø14 mm	55	414	60	400
181.F14.0650.*	Ø14 mm	55	664	60	650
181.F16.0125.*	Ø16 mm	55	141	60	125
181.F16.0200.*	Ø16 mm	55	216	60	200
181.F16.0300.*	Ø16 mm	55	316	60	300
181.F16.0400.*	Ø16 mm	55	416	60	400
181.F16.0650.*	Ø16 mm	55	666	60	650
181.F19.0125.*	Ø19 mm	60	144	75	125
181.F19.0200.*	Ø19 mm	60	219	75	200
181.F19.0300.*	Ø19 mm	60	319	75	300
181.F19.0400.*	Ø19 mm	60	419	75	400
181.F19.0650.*	Ø19 mm	60	669	75	650

<sup>1)</sup> Montagesæt findes på side 40

<sup>2)</sup> Ved bestilling nævn om der ønskes hul- eller gevinddel

<sup>3)</sup> Ved bestilling af huldell medfølger pinolskrue og MB gevinddel

## Montagesæt for Randi-Line 1512/1513/1514

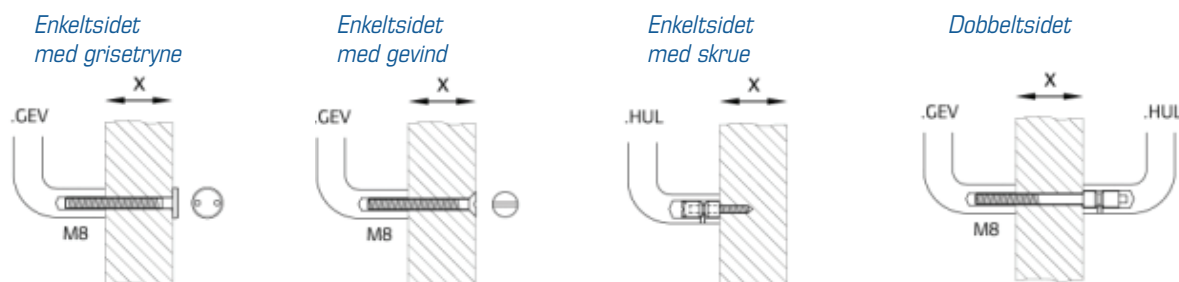

### Glasdøre 10 - 22 mm

Dørtykkelse	Enkelt-sided m. grisetryne	Enkelt-sided m. gevind	Enkelt-sided m. skrue	Dobbelt-sided
10 - 22 mm	181.530.02M.A00	181.740.71G.A00	-	181.530.40S.A00

### Massive døre 23 - 102 mm

Dørtykkelse	Enkelt-sided m. grisetryne	Enkelt-sided m. gevind	Enkelt-sided m. skrue	Dobbelt-sided
23 - 30 mm	181.530.02M.B00	181.740.71G.B00	-	181.530.40S.B00
31 - 42 mm	181.530.02M.C00	181.740.71G.C00	181.530.50T.000	181.530.40S.C00
43 - 54 mm	181.530.02M.D00	181.740.71G.D00	181.530.50T.000	181.530.40S.D00
55 - 66 mm	181.530.02M.E00	181.740.71G.E00	181.530.50T.000	181.530.40S.E00
67 - 78 mm	181.530.02M.F00	181.740.71G.F00	181.530.50T.000	181.530.40S.F00
79 - 90 mm	181.530.02M.G00	181.740.71G.G00	181.530.50T.000	181.530.40S.G00
91 - 102 mm	-	-	181.530.50T.000	181.530.40S.H00

## Montagesæt for Randi Line 1532/1533/1534

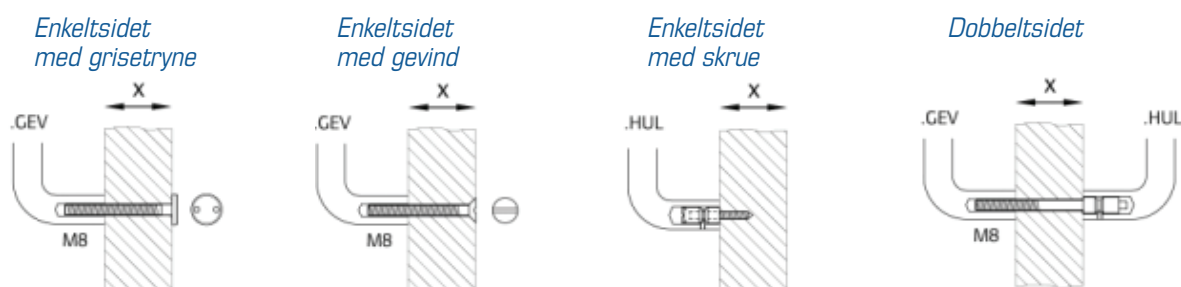

### Glasdøre 10 - 22 mm

Dørtykkelse	Enkelt-sided m. grisetryne	Enkelt-sided m. gevind	Enkelt-sided m. skrue	Dobbelt-sided
10 - 22 mm	181.530.02M.A00	181.740.71G.A00	-	181.530.40S.A00

### Massive døre 23 - 102 mm

Dørtykkelse	Enkelt-sided m. grisetryne	Enkelt-sided m. gevind	Enkelt-sided m. skrue	Dobbelt-sided
23 - 30 mm	181.530.02M.B00	181.740.71G.B00	-	181.530.40S.B00
31 - 42 mm	181.530.02M.C00	181.740.71G.C00	181.530.50T.000	181.530.40S.C00
43 - 54 mm	181.530.02M.D00	181.740.71G.D00	181.530.50T.000	181.530.40S.D00
55 - 66 mm	181.530.02M.E00	181.740.71G.E00	181.530.50T.000	181.530.40S.E00
67 - 78 mm	181.530.02M.F00	181.740.71G.F00	181.530.50T.000	181.530.40S.F00
79 - 90 mm	181.530.02M.G00	181.740.71G.G00	181.530.50T.000	181.530.40S.G00
91 - 102 mm	-	-	181.530.50T.000	181.530.40S.H00

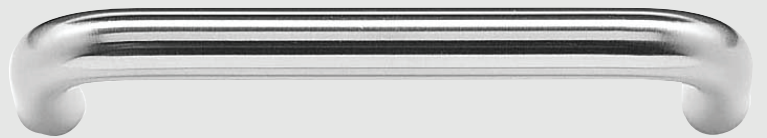

 **Randi**

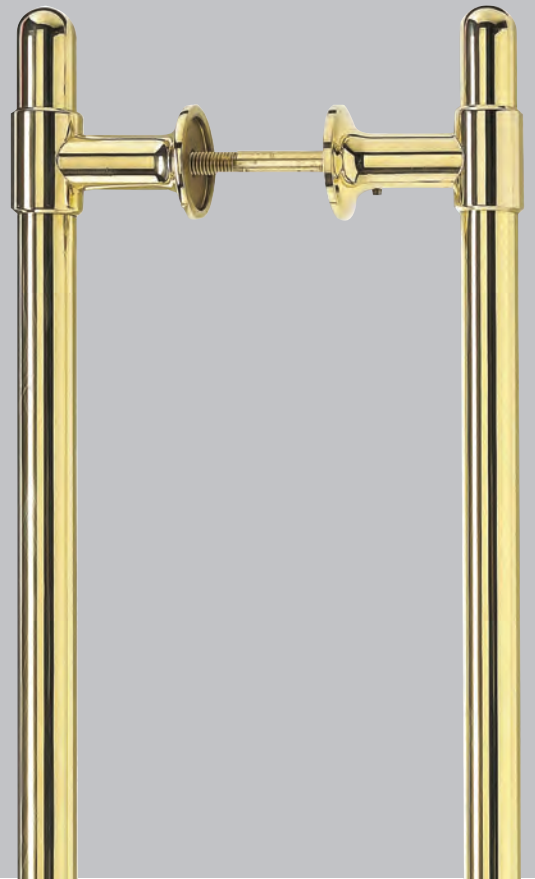

## Dørhanke • d line

Produktoversigt . . . . . 4

Rustfrit stål:

U-hanke . . . . . 43

Forkrøppet . . . . . 43

Bolte . . . . . 44

### d line

d line har næsten 50 års erfaring med udvikling af designserier, som omfatter bl.a. dørgreb, besætninger og sanistetstilbehør. d-line er håndværk baseret på passion og bæredygtighed – dansk design i højeste kvalitet, som leveres til alle verdenshjørner. d line har rødder tilbage til en ung Knud Holscher, som i 1960'erne var lærling ved Arne Jacobsen.



## Knud Holscher

U-hank, mat slebet, AISI 316, rustfrit stål

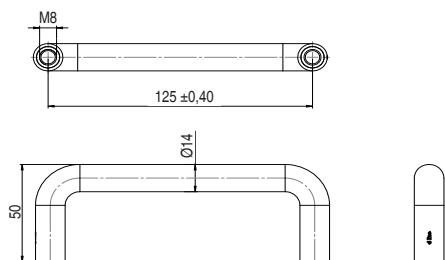

Varenummer.	diameter	TL	dybde	C/C
182.U14.0125.*	Ø14	139	50	125
182.U14.0300.*	Ø14	314	50	300
182.U14.0650.*	Ø14	664	50	650
182.U19.0125.*	Ø19	144	65	125
182.U19.0200.*	Ø19	219	65	200
182.U19.0300.*	Ø19	319	65	300
182.U19.0400.*	Ø19	419	65	400
182.U19.0450.*	Ø19	469	65	450
182.U19.0650.*	Ø19	669	65	650
182.U25.0300.*	Ø25	325	70	300
182.U25.0650.*	Ø25	675	70	650
182.U32.0300.*	Ø32	332	80	300
182.U32.0600.*	Ø32	632	80	600

<sup>1)</sup> Montagebolte findes på side 44

<sup>2)</sup> Ved bestilling nævn om der ønskes hul- eller gevinddel



Knud Holscher forkrøppet hank, mat slebet, AISI 316, rustfrit stål

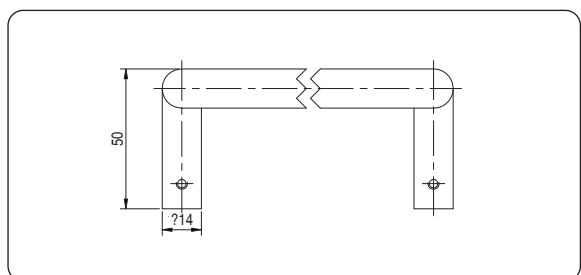
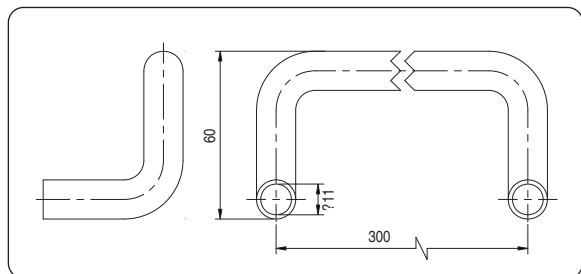

Varenummer.	diameter	bredde	dybde	C/C
182.F14.0125.*	Ø14	60	50	125
182.F14.0300.*	Ø14	60	50	300
182.F14.0650.*	Ø14	60	50	650
182.F19.0125.*	Ø19	73	65	125
182.F19.0300.*	Ø19	73	65	300
182.F19.0400.*	Ø19	73	65	400
182.F19.0650.*	Ø19	73	65	650
182.F25.0300.*	Ø25	95	70	300
182.F25.0650.*	Ø25	95	70	650
182.F32.0300.*	Ø32	110	80	300
182.F32.0650.*	Ø32	110	80	600

<sup>1)</sup> Montagebolte findes på side 44

<sup>2)</sup> Ved bestilling nævn om der ønskes hul- eller gevinddel

**Bolt** for dobbeltsidet hank Ø14, Ø19, Ø25 og Ø32 mm



Varenummer.	overflade	for hank	mål
182.491.592.380	elforzinket	Ø14/19	M8 x 30 mm
182.491.592.584	elforzinket	Ø14/19	M8 x 58 mm
182.491.592.983	elforzinket	Ø14/19	M8 x 98 mm
182.491.792.109	elforzinket	Ø25	M10 x 100 mm
182.491.692.309	elforzinket	Ø32	M12 x 30 mm
182.491.692.601	elforzinket	Ø32	M12 x 60 mm
182.491.692.104	elforzinket	Ø32	M12 x 100 mm

**Bolt** for enkeltsidet hank, AISI 316 rustfrit stål, Ø14, Ø19 og Ø25 mm

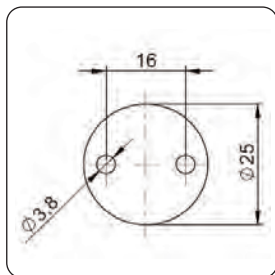

Varenummer.	overflade	for hank	mål
182.492.002.306	matslebet	Ø25	M10 x 60 mm
182.492.002.900	matslebet	Ø25	M10 x 90 mm
182.492.202.607	matslebet	Ø14/19	M8 x 30 mm
182.492.202.909	matslebet	Ø14/19	M8 x 90 mm

8



d line

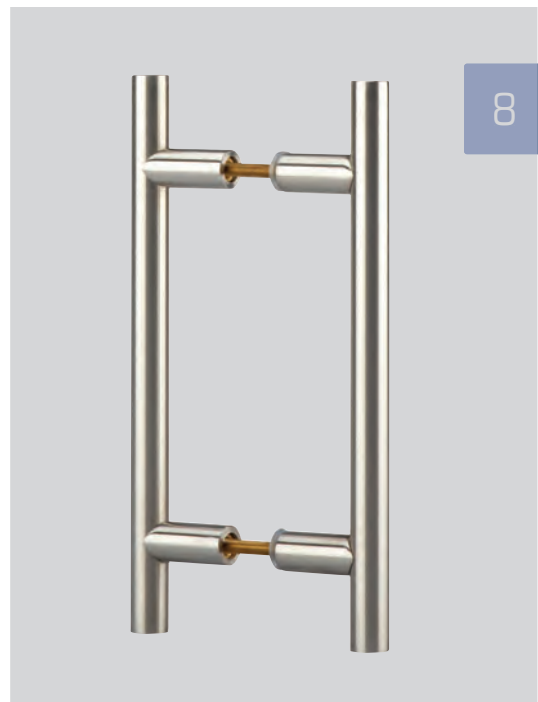

 *Stremler*  
ASSA ABLOY

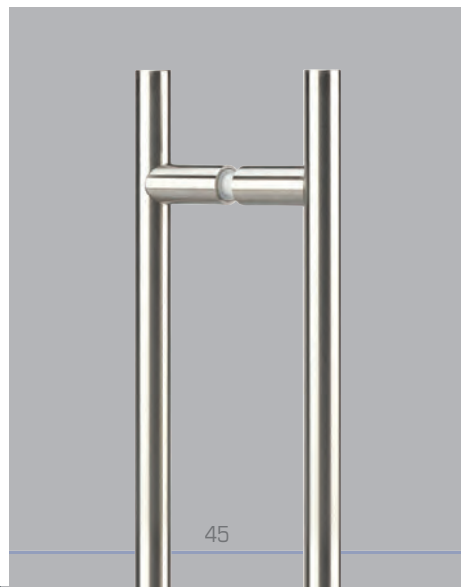



ASSA ABLOY

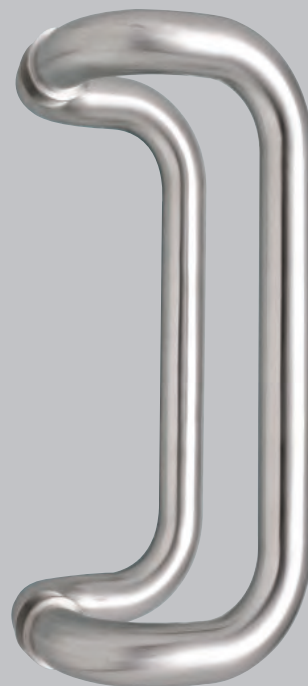

8

pop



47





## Hansen Lellinge glas- og dørteknik til professionelle

Hansen Lellinge A/S leverer løsninger til glaskonstruktioner og dørteknik fra anerkendte kvalitetsleverandører af profil-systemer, beslag, låse, dørautomatik og glarmesterprodukter.

Vi yder kompetent teknisk og praktisk rådgivning og deltager gerne i projekter fra idéfase til færdiggørelse.

Vores udstilling og vore faguddannede medarbejdere står til rådighed og vi henviser gerne til relevante håndværkere.

Vi lagerfører et omfattende sortiment af produkter og tilbehør for hurtig levering og har eget værksted for tilpasning og specialløsninger.

**HANSEN  LELLINGE**

Hansen Lellinge A/S  
Mårkærvej 7  
2630 Taastrup  
[www.hansenlellinge.dk](http://www.hansenlellinge.dk)  
[info@hansenlellinge.dk](mailto:info@hansenlellinge.dk)  
Kundeservice: 43 71 16 40

